

**ATC990 Graphical Controller and
UPR900 Process Indicator
with optional USB & Data Logging
User Manual**



Drawing Number: 974158

This manual supplements the Concise Product manual(s) supplied with each instrument at the time of shipment. Information in this installation, wiring and operation manual is subject to change without notice.

Copyright © January 22, 2013, Dynisco LLC, all rights reserved. No part of this publication may be reproduced, transmitted, transcribed or stored in a retrieval system, or translated into any language in any form by any means without the written permission of Dynisco Plastics .

Copies of this manual are available in electronic format on the Dynisco web site (www.Dynisco-com)

It is strongly recommended that applications incorporate a high or low limit protective device, which will shut down the equipment at a preset process condition in order to prevent possible damage to property or products.



WARNING:

THE INTERNATIONAL HAZARD SYMBOL IS INSCRIBED ADJACENT TO THE REAR CONNECTION TERMINALS. IT IS IMPORTANT TO READ THIS MANUAL BEFORE INSTALLING OR COMMISSIONING THE UNIT.

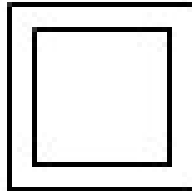

WARNING:

THIS SYMBOL MEANS THE EQUIPMENT IS PROTECTED THROUGHOUT BY DOUBLE INSULATION.

Products covered by this manual are suitable for Indoor use, Installation Category II, Pollution category 2 environments.

This user guide covers the Dynisco ATC990 controller and UPR900 indicator.



WRITTEN OR ORAL, EXPRESS OR IMPLIED, IN FACT OR BY OPERATION OF LAW, STATUTORY OR OTHERWISE, INCLUDING WARRANTIES OF MERCHANTABILITY, FITNESS FOR A PARTICULAR PURPOSE, SATISFACTORY QUALITY, ADHERENCE TO DESCRIPTION, AND NONINFRINGEMENT, ALL OF WHICH ARE HEREBY EXPRESSLY DISCLAIMED. IN NO EVENT SHALL SELLER BE LIABLE TO BUYER OR ANY THIRD PARTY FOR ANY OTHER DAMAGES, INCLUDING WITHOUT LIMITATION ANY SPECIAL, INDIRECT, CONSEQUENTIAL, INCIDENTAL, EXEMPLARY, OR PUNITIVE DAMAGES OF ANY KIND.

THE TOTAL LIABILITY OF SELLER FOR DAMAGES, WHETHER IN CONTRACT OR IN TORT (INCLUDING NEGLIGENCE, WHETHER SOLE OR CONCURRENT), OR OTHERWISE, ARISING OUT OF OR CONNECTED WITH OR RESULTING FROM THE MANUFACTURE, SALE, DELIVERY, RESALE, REPAIR, REPLACEMENT OR USE OF ANY PRODUCTS HEREUNDER SHALL NOT EXCEED THE PURCHASE PRICE PAID BY BUYER FOR THE PRODUCT OR PART THEREOF GIVING RISE TO THE CLAIM.

How to use this manual

This manual is structured to give easy access to the information required for all aspects of the installation and use and of the ATC Controller. The main sections are shown here, followed by a full table of contents.

- Section 1: **Introduction** - A brief description of the product and its features.
- Section 2: **Installation** - Unpacking, installing and panel mounting instructions.
- Section 3: **Wiring Instructions** - Guidance on good wiring practice, noise avoidance, wiring diagrams and input/output connections.
- Section 4: **Powering Up** - Powering up procedure and descriptions of displays & switches.
- Section 5: **Messages & Error Indications** - Display Messages and fault indications.
- Section 6: **Configuration & Use** - Describes operating and configuration modes available. These include Operation Mode; the Main and Configuration menus; the Easy Setup Wizard; Supervisor Mode; Automatic tuning; Product and Service Information. Also available on some models are menus to setup the USB and Data Recorder.
- Section 7: **The USB Interface Option** – Describes uploading or downloading of instrument settings, or recorder logs to a USB memory stick.
- Section 8: **The Data Recorder Option** – Describes the Data recorder feature. This allows process data to be stored in to memory for later download and analysis.
- Section 9: **Manually Tuning Controllers** - Advice on manually adjusting the controller to the process characteristics.
- Sections 10: **Serial Communications** - Details the physical layer and message formats used for the RS485 and Ethernet communications options.
- Sections 11: **Modbus Parameters** - Details the parameter addresses and data formats used for the Modbus RTU and TCP communications protocols.
- Section 12: **Calibration** - Step-by-step instructions to calibrate the instrument. This section is intended for use by suitably qualified personnel.
- Appendix 1: **Glossary** - Explanations of the terms used and product features.
- Appendix 2: **Automatic Stand-by** – Description of automatic stand-by functionality
- Appendix 3: **PC Software** – Using the software suite.
- Appendix 4: **Specifications** - Technical specifications for all products in the range.
-

Contents

Page Number:

Warranty and Returns Statement	2
1 Introduction.....	12
2 Installation	13
Unpacking	13
Installation	13
Panel-Mounting	13
Cleaning	14
3 Electrical Installation.....	15
Installation Considerations	15
AC Power Wiring - Neutral (for 100-264 V AC versions)	15
Wire Isolation	15
Use of Shielded Cable	16
Noise Suppression at Source	16
Sensor Placement (Thermocouple or RTD)	17
Thermocouple Wire Identification Chart	17
Connections and Wiring	18
Power Connections	19
Universal Input Connections	20
Option Slot 1 Connections.....	23
Option Slot 2 Connections.....	23
Option Slot 3 Connections.....	24
Option Slot A Connections	25
4 Powering Up.....	26
Powering Up Procedure	26
Front Panel Overview	26
Display	26
LED Functions	27
Keypad	27
5 Messages and Error Indications.....	29
Start-up Errors	29
Input Problems	29
USB Data Transfer Problems	30
6 Configuration and Use	31
Operation Mode	31
Base, & Trend e Operating Screens	31
Adjusting the Local Setpoint(s).....	34
Adjusting the Setpoint Ramp Rate	35
Selecting Automatic or Manual Mode.....	35
Control Enable or Disable.....	35

Main Menu	36
Entry into the Main Menu	36
Unlock Codes	36
Setup Wizard	37
Manual entry to the Setup Wizard	37
Supervisor Mode	38
Entry into Supervisor Mode	38
Configuration Menu	39
Entry into the Configuration Menu	39
Hierarchy Chart of Configuration Menu	40
Input Configuration Sub-Menu	41
Control Configuration Sub-Menu	44
Output Configuration Sub-Menu	46
Alarm Configuration Sub-Menu	46
Communications Configuration Sub-Menu	47
Recorder Configuration Sub-Menu	47
Clock Configuration Sub-Menu	48
Display Configuration Sub-Menu	49
Lock Code View	50
Lost Lock Codes	50
Resetting To Defaults	51
Automatic Tuning Menu	51
USB Menu	52
Recorder Menu	53
Product Information Mode	53
Service Information Mode	54
7 The USB Interface	4
Using the USB Port	Err
or! Bookmark not defined.	
USB Memory Stick Folders & Files	Error! Bookmark not defined.
8 The Data Recorder Option	Error! Bookmark not defined.
Introduction	Err
or! Bookmark not defined.	
Changes To Operation Mode	Err
or! Bookmark not defined.	
9 Manually Tuning Controllers	8

	Single Control Tuning (PI with Primary Output only)		Err
	or! Bookmark not defined.		
	Dual Control Tuning (PI with Primary and Secondary Outputs)		Err
	or! Bookmark not defined.		
	PI Tuning (Valve, Damper & Speed Controllers)		Err
	or! Bookmark not defined.		
	Fine Tuning.		59
10	Serial Communications	Error! Bookmark not defined.	
	Supported Protocols		Err
	or! Bookmark not defined.		
	RS485 Configuration		Err
	or! Bookmark not defined.		
	Ethernet Configuration		Err
	or! Bookmark not defined.		
	Supported Modbus Functions		Err
	or! Bookmark not defined.		
	Function Descriptions		Err
	or! Bookmark not defined.		
	Exception Responses	Error! Bookmark not defined.	
11	Modbus Parameters	Error! Bookmark not defined.	
	Example Register Address Calculations	Error! Bookmark not defined.	
	Universal Process Input Parameters		Err
	or! Bookmark not defined.		
	Option Slot A Parameters		68
	Option Slot B Parameters		69
	Option Slot 1 Parameters		70
	Option Slot 2 Parameters		
	or! Bookmark not defined.		Err
	Option Slot 3 Parameters		
	or! Bookmark not defined.		Err

Option Slot 4 Parameters	78
Setpoint Parameters	
	Err
or! Bookmark not defined.	
Control Parameters	
	Err
or! Bookmark not defined.	
Alarm parameters	
	Err
or! Bookmark not defined.	
Recorder & Clock Parameters	
	Err
or! Bookmark not defined.	
Display Parameters	
	Err
or! Bookmark not defined.	
Instrument Data	
	Err
or! Bookmark not defined.	
12 Calibration 37	37
Calibration Reminder	37
Equipment Required For Checking or Calibrating The Universal Input	37
Calibration Check	37
Recalibration Procedure	38
13 Appendix 1 – Glossary of Terms Used 39	39
Active Setpoint	39
Actual Setpoint	39
Alarm Configuration	39
Alarm Operation	41
Alarm Inhibit	42
Alarm Types	42
Alternative Setpoint	42
Auto Pre-Tune	42
Automatic Reset	42
Auxiliary Input	43
Auxiliary Input Lower Limit	43
Auxiliary Input Offset	
	Err
or! Bookmark not defined.	
Auxiliary Input Type	43
Auxiliary Input Upper Limit	43

Band Alarm Value	43
Bar Graphs	43
Bias (Manual Reset)	43
Bumpless Transfer	44
Cascade Control	44
Clock Configuration	45
Communications Write Enable	45
Configuration Menu	45
Contactors	45
Control Configuration	45
Control Deviation	45
Control Action	45
Control Enable/Disable	46
Control Type	46
Controller	46
Controller Mode	
	Err
or! Bookmark not defined.	
Correcting Variable	46
CPU	46
Current Proportioning Control	46
Custom Display Mode	46
Cycle Time	47
Data Recorder	47
Deadband	108
Derivative Action	47
Deviation Alarm Value	47
Digital Input	47
Direct Acting Control	48
Display Configuration	48
Display Languages	
	Err
or! Bookmark not defined.	
Display Resolution	48
Effective Setpoint	48
Engineering Units	48
Ethernet	48
Indicator	49
Input Configuration	49
Input Filter Time Constant	49
Input Range	49

Input Span	49
Integral Time Constant	49
Latching Relay	50
LED	50
Linear Input	50
Linear Output	50
Limit Controller	50
Local Setpoints	50
Lock Codes	50
Logical Combination of Alarms	51
Loop Alarm	51
LSD	52
mADC	52
Main Menu	52
Manual Loop Alarm Time	52
Manual Mode	52
Master & Slave Controllers	53
Minimum Duration Of Change	53
Modbus RTU	53
Modbus TCP	54
Modulating Valve	54
Multi-Point Scaling	54
mVDC	54
On-Off Control	55
On-Off Differential (On-Off Hysteresis)	55
Operation Mode	55
Output Configuration	55
Overlap/Deadband	55
PI Control	57
PI Control	58
PLC	58
Pre-Tune	58
Power Output Limits	59
Primary Proportional Band	60
Process High Alarm <i>n</i> Value	60
Process Input	60
Process Low Alarm <i>n</i> Value	60
Process Variable (PV)	60
Process Variable Offset	61
Proportional Control	61
Rate	61

Rate Of Change Alarm	61
Recorder Configuration	61
Recorder Option	61
Recorder Menu	61
Relay	62
Remote Setpoint (RSP)	62
Retransmit Output	62
Retransmit Output <i>n</i> Scale Maximum	62
Retransmit Output <i>n</i> Scale Minimum	62
Reset To Defaults	63
Reverse Acting Control	63
RS485	63
RTD	63
Scale Range Upper Limit	64
Scale Range Lower Limit	64
Secondary Proportional Band	64
Self-Tune	64
Sensor Break Pre-Set Power	65
Serial Communications Configuration	65
Serial Communications Option	65
Setpoint	127
Setpoint Upper Limit	66
Setpoint Lower Limit	66
Setpoint Ramp Editing	66
Setpoint Ramp Rate	66
Setpoint Selection	67
Setup Wizard	67
Solid State Relay (SSR)	67
Supervisor Mode	67
Thermocouple	68
Three Point Stepping Control	68
Time Proportioning Control	68
Trend Display	68
Tuning	69
Tuning Menu	69
USB Menu	69
Valve Motor Drive Control (VMD)	69
VDC	70
VMD	70
14 Appendix 2 – Automatic Stand-by	132
Automatic Stand-by Feature	132

Using Automatic Stand-by	132
Automatic Stand-by Example	133
Finding the Steady State Power	133
Using Stand-by Active Limit	134
15 Appendix 3 - PC SOFTWARE	71
Using The Software	Err
or! Bookmark not defined.	
Instrument Configuration	Err
or! Bookmark not defined.	
Changing the Start-up Splash Screen	Err
or! Bookmark not defined.	
Changing the Alternate Display Language	Err
or! Bookmark not defined.	
Instrument Simulation	Err
or! Bookmark not defined.	
Configuring The Connection	Err
or! Bookmark not defined.	
Network Configuration For Modbus TCP Options	Err
or! Bookmark not defined.	
16 Appendix 4 - Specifications.....	Error! Bookmark not defined.
Universal Process Input	Err
or! Bookmark not defined.	
General Input Specifications.....	Error! Bookmark not defined.
Thermocouple Input.....	Error! Bookmark not defined.
Resistance Temperature Detector (RTD) Input.....	Error! Bookmark not defined.
DC Linear Input.....	Error! Bookmark not defined.
Auxiliary Inputs	Err
or! Bookmark not defined.	
Digital Inputs	Err
or! Bookmark not defined.	

Output Specifications

Err

or! Bookmark not defined.

Communications

Err

or! Bookmark not defined.

Display

Err

or! Bookmark not defined.

Control Loop

Err

or! Bookmark not defined.

Data Recorder Option

Err

or! Bookmark not defined.

Alarms

Err

or! Bookmark not defined.

Conditions For Use

Err

or! Bookmark not defined.

Standards

Err

or! Bookmark not defined.

Dimensions

Err

or! Bookmark not defined.

1 Introduction

This product is a $\frac{1}{4}$ DIN size (96 x 96mm front) microprocessor based graphical process controller or indicator, featuring a 160 x 80 pixel, monochrome LCD with a dual colour (red/green) backlight. It can control process variables from a variety of sources such as strain gauge, temperature, pressure, flow and level.

The operating voltage is either 100-264 Vac at 50/60 Hz or 24V-48V AC/DC depending on the model purchased. Optional features include a USB interface, RS485 or Ethernet communications, and data recording. Non-volatile memory protects against data or configuration loss during power outages. If the unit is left un-powered, a lithium battery powers the data recorder's real-time clock for a minimum of one year.

The USB Interface option allows uploading or downloading instrument configuration settings to/from a USB memory stick, for easy configuration of multiple instruments or transfer to/from the PC configuration software. If the Data Recorder option is fitted, recordings can also be transferred via the memory stick.

The Data Recorder option allows the user to make recordings of the process over time. Recordings can be transferred to a memory stick using the USB Port or downloaded using one of the communications options.

Inputs are user configurable for strain gauge thermocouple and RTD probes, as well as linear process signal types such as mVDC, VDC or mADC. Multipoint scaling can compensate for non-linear signals. Output options include relays, SSR drivers, or linear mV/voltage modules. These can be used for process control, alarms or retransmission of the process variable or set point to external devices. Transmitter Power Supply options can provide an unregulated 24V DC (45mA) auxiliary output voltage, or a 0 to 10VDC stabilised excitation for external signal transmitters.

Alarm indication is standard on all instruments; up to three alarms can be defined. Alarms may be set as process high or low, deviation (active above or below controller set point), band (active both above and below set point), rate of input change, control loop or signal break types. Alarm status can be indicated by lighting an LED, changing the display backlight colour or viewing the alarm status screen. These alarms can be linked to any suitable output.

The controller can be programmed for on-off, time proportioning, or current proportioning control implementations, depending on the output modules fitted, and feature manual or automatic tuning of the PI parameters. A secondary control output is available when additional output modules are fitted. Optional analogue Remote Set point inputs can be included. Configuration of the major settings is made easy by a Setup Wizard that runs automatically at first ever power-up or whenever option modules have been changed. Access to the full range of parameters is via a simple menu driven front panel interface, or the PC based configuration software.

2 Installation

Unpacking

1. Remove the product from its packing. Retain the packing for future use, in case it is necessary to transport the instrument to a different site or to return it to the supplier for repair/testing.
2. The instrument is supplied with a panel gasket and push-fit fixing strap. Concise manual(s) are supplied with the instrument.. Examine the delivered items for damage or defects. If any are found, contact your supplier immediately.

Installation

CAUTION:

Installation should be only performed by technically competent personnel. It is the responsibility of the installing engineer to ensure that the configuration is safe. Local Regulations regarding electrical installation & safety must be observed (e.g. US National Electrical Code (NEC) or Canadian Electrical Code).

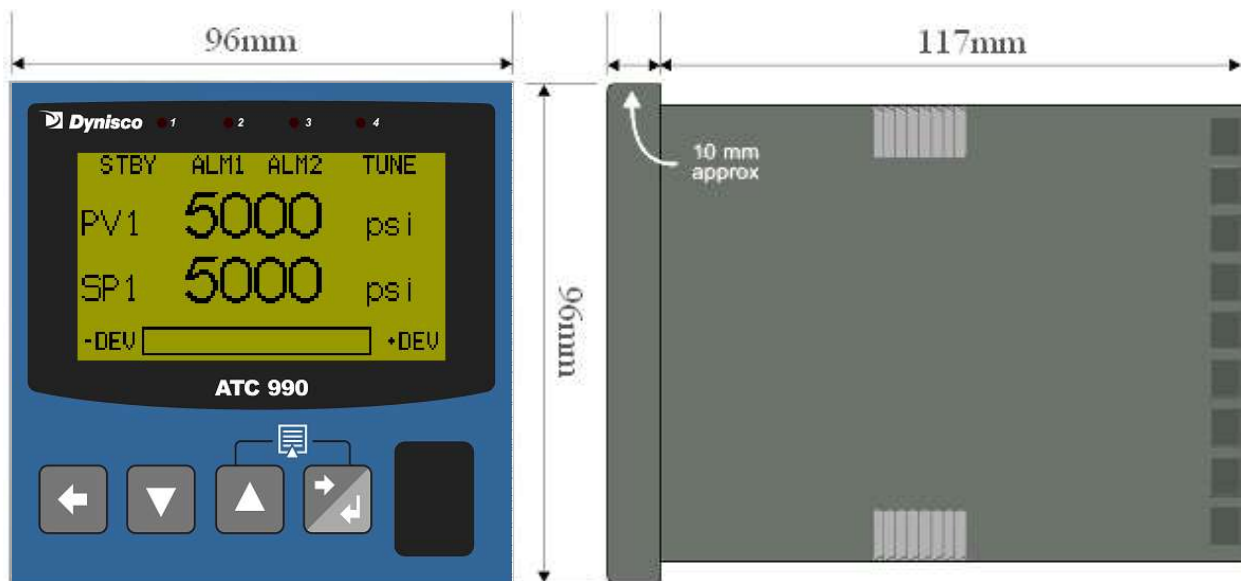

Figure 1. Main dimensions

Panel-Mounting

The mounting panel must be rigid and may be up to 6.0mm (0.25 inches) thick. The cut-out size is:

3.62" (92mm) x 3.62(92mm) (+0.5mm / -0.0mm).

Instruments may be mounted side-by-side in a multiple installation, but instrument to panel moisture and dust sealing will be compromised. Allow a 20mm gap above, below and behind the instrument for ventilation. The cut-out width (for n instruments) is:

$$(96n - 4) \text{ mm or } (3.78n - 0.16) \text{ inches}$$

If panel sealing must be maintained, mount each instrument into an individual cut-out with 6mm or more clearance between the edges of the holes.

Note:

The mounting clamp tongues may engage the ratchets either on the sides or the top/bottom faces of the Instrument housing. When installing several Instruments side-by-side in one cut-out, use the ratchets on the top/bottom faces.

CAUTION:

Ensure the inside of the panel remains within the instrument operating temperature and that there is adequate airflow to prevent overheating.

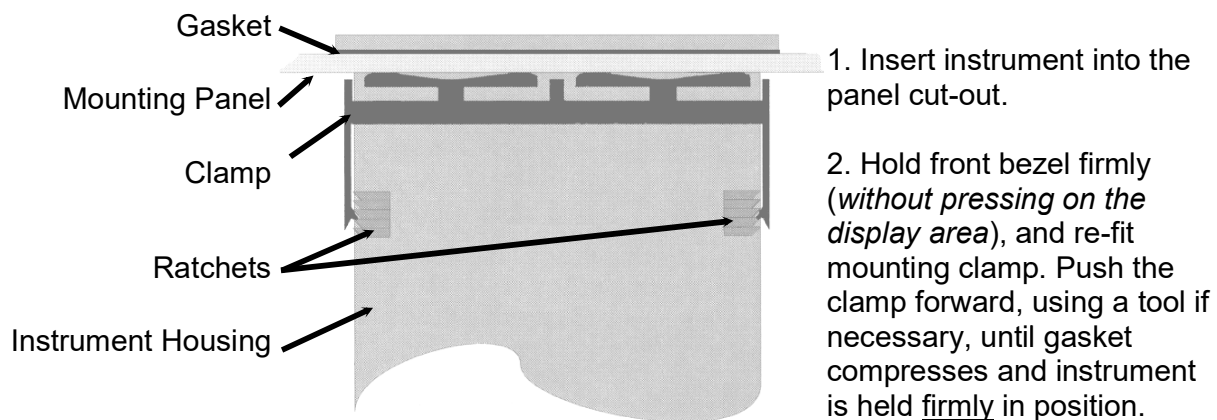

Figure 2. Panel-Mounting the instrument

Note:

For an effective IP66 seal against dust and moisture, ensure gasket is well compressed against the panel, with the 4 tongues located in the same ratchet slot.

CAUTION:

Do not remove the panel gasket, as this may result in inadequate clamping and sealing of the instrument to the panel.

Once the instrument is installed in its mounting panel, it may be subsequently removed from its housing, if necessary, as described in the Fitting and Removing Option Modules section.

Cleaning

Clean the front panel by washing with warm soapy water and dry immediately if the USB option is fitted, close the USB port cover before cleaning.

3 Electrical Installation

CAUTION:

Installation should be only performed by technically competent personnel. It is the responsibility of the installing engineer to ensure that the configuration is safe. Local Regulations regarding electrical installation & safety must be observed (e.g. US National Electrical Code (NEC) or Canadian Electrical Code).

Installation Considerations

Ignition transformers, arc welders, motor drives, mechanical contact relays and solenoids are examples of devices that generate electrical noise in typical industrial environments. The following guidelines MUST be followed to minimise their effects.

1. If the instrument is being installed in existing equipment, the wiring in the area should be checked to ensure that good wiring practices have been followed.
2. Noise-generating devices such as those listed should be mounted in a separate enclosure. If this is not possible, separate them from the instrument, by the largest distance possible.
3. If possible, eliminate mechanical contact relays and replace with solid-state relays. If a mechanical relay being powered by an output of this instrument cannot be replaced, a solid-state relay can be used to isolate the instrument.
4. A separate isolation transformer to feed only the instrumentation should be considered. The transformer can isolate the instrument from noise found on the AC power input.

AC Power Wiring - Neutral (for 100-264 V AC versions)

It is good practice to ensure that the AC neutral is at or near ground (earth) potential. A proper neutral will help ensure maximum performance from the instrument.

Wire Isolation

Four voltage levels of input and output wiring may be used with the unit:

1. Analogue input or output (for example thermocouple, RTD, VDC, mVDC or mADC)
2. Relays outputs
3. AC power

CAUTION:

The only wires that should run together are those of the same category.

If any wires need to run parallel with any other lines, maintain a minimum space of 150mm between them.

If wires MUST cross each other, ensure they do so at 90 degrees to minimise interference.

Use of Shielded Cable

All analogue signals must use shielded cable. This will help eliminate electrical noise induction on the wires. Connection lead length must be kept as short as possible keeping the wires protected by the shielding. The shield should be grounded at one end only. The preferred grounding location is at the sensor, transmitter or transducer.

Noise Suppression at Source

Usually when good wiring practices are followed, no further noise protection is necessary. Sometimes in severe electrical environments, the amount of noise is so great that it has to be suppressed at source. Many manufacturers of relays, contactors etc supply 'surge suppressors' which mount on the noise source. For those devices that do not have surge suppressors supplied, Resistance-Capacitance (RC) networks and/or Metal Oxide Varistors (MOV) may be added.

Inductive coils:- MOVs are recommended for transient suppression in inductive coils, connected in parallel and as close as possible to the coil. Additional protection may be provided by adding an RC network across the MOV.

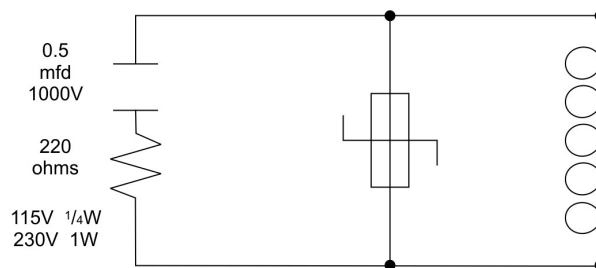

Figure 3. Transient suppression with inductive coils

Contacts:- Arcing may occur across contacts when they open and close. This results in electrical noise as well as damage to the contacts. Connecting a properly sized RC network can eliminate this arc.

For circuits up to 3 amps, a combination of a 47 ohm resistor and 0.1 microfarad capacitor (1000 volts) is recommended. For circuits from 3 to 5 amps, connect two of these in parallel.

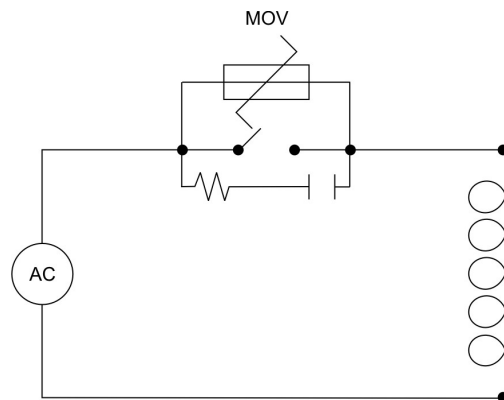

Figure 4. Contact noise suppression

Sensor Placement (Thermocouple or RTD)

If the temperature probe is to be subjected to corrosive or abrasive conditions, it must be protected by an appropriate thermowell. The probe must be positioned to reflect true process temperature:

1. In a liquid media - the most agitated area
2. In air - the best circulated area

CAUTION:

The placement of probes into pipe work some distance from the heating vessel leads to transport delay, which results in poor control.

For a two wire RTD, a wire link should be used in place of the third wire (see the wiring section for details). Two wire RTDs should only be used with lead lengths less than 3 metres. Use of three wire RTDs is strongly recommended to reduce errors do to lead resistance.

Thermocouple Wire Identification Chart

The different thermocouple types are identified by their wires colour, and where possible, the outer insulation as well. There are several standards in use throughout the world.

The table below shows the wire and sheath colours used for most common thermocouple types. The format used in this table is:

+ Wire	Sheath
- Wire	

Table 1. Thermocouple Extension Wire Colours

Type	International IEC584-3	USA ANSI MC 96.1	British BS1843	French NFC 42-324	German DIN 43710
J	+* Black Black	White Black	Yellow Black	Yellow Black	Red Blue
	- White Black	Red Black	Blue Black	Black Black	Blue Blue
T	+ Brown Brown	Blue Blue	White Blue	Yellow Blue	Red Brown
	- White Brown	Red Blue	Blue Blue	Blue Blue	Brown Brown
K	+ Green Green	Yellow Yellow	Brown Red	Yellow Yellow	Red Green
	-* White Green	Red Yellow	Blue Red	Purple Yellow	Green Green
N	+ Pink Pink	Orange Orange	Orange Orange		
	- White Pink	Red Orange	Blue Orange		
B	+ Grey Grey	Grey Grey			Red Grey
	- White Grey	Red Grey			Grey Grey
R & S	+ Orange Orange	Black Green	White Green	Yellow Green	Red White
	- White Orange	Red Green	Blue Green	Green Green	White White
C (W5)			White White		
			Red White		

Note:

* = Wire is magnetic

Connections and Wiring



This symbol means the equipment is protected throughout by double insulation.

CAUTION:

All external circuits connected must provide double insulation. Failure to comply with the installation instructions may impact the protection provided by the unit.

WARNING:

TO AVOID ELECTRICAL SHOCK, AC POWER WIRING MUST NOT BE CONNECTED TO THE SOURCE DISTRIBUTION PANEL UNTIL ALL WIRING PROCEDURES ARE COMPLETED. CHECK THE INFORMATION LABEL ON THE CASE TO DETERMINE THE CORRECT VOLTAGE BEFORE CONNECTING TO A LIVE SUPPLY.

Note:

The wiring diagram below shows all possible combinations to the main connections (numbered 1 to 24) in the centre of the case rear. The actual connections required depend upon the features available on the model and the modules and options fitted.

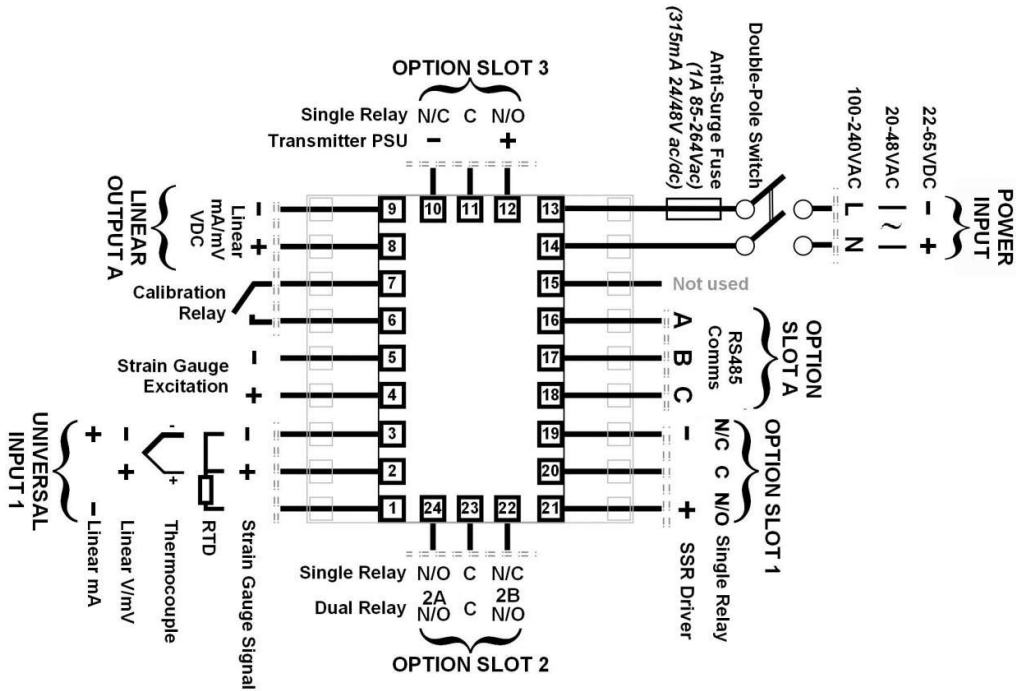

Figure 5. Main Rear terminals

Note:

The wiring diagram below shows the additional connections (numbered 25 to 42) at the sides of the case rear. These are required for Options Slots 4 and C if fitted.

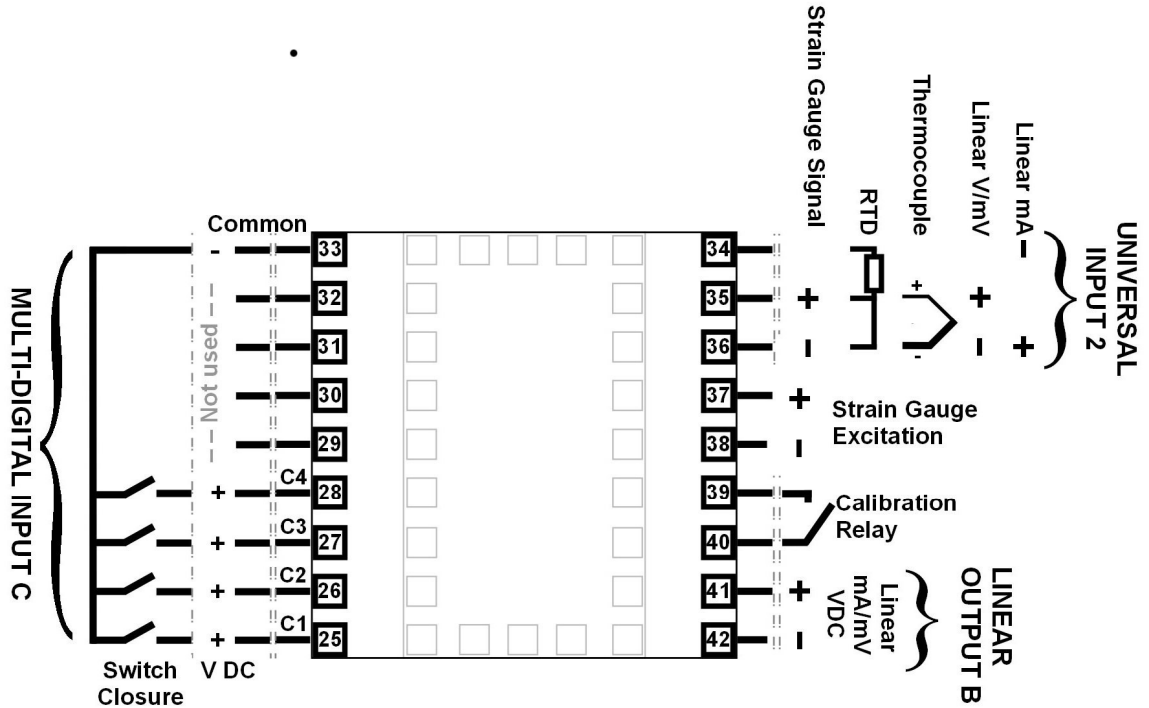

Figure 6. Additional Option terminals

Note:

Use single strand (1.2mm / AWG18 max size) copper wire throughout, except for the thermocouple input, where the correct thermocouple or compensating cable and connectors must be used.

Power Connections

Power Connections - Mains Powered Instruments

Mains powered instruments operate from a 100 to 240V (±10%) 50/60Hz supply. Power consumption is 24VA. Connect the line voltage (live and neutral) as illustrated via a two-pole IEC60947-1 & IEC60947-3 compliant isolation switch / circuit breaker and a UL listed fuse type: 250V AC 1Amp anti-surge. If the instrument has relay outputs with contacts carrying mains voltage, it is recommended that the relay contacts supply should be switched and fused in a similar manner, but should be separate from the instruments mains supply.

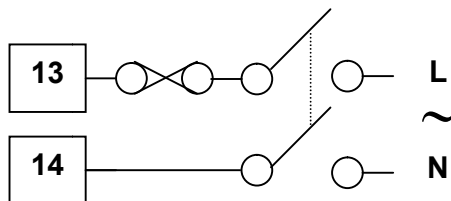

Figure 7. Mains Power Connections

WARNING:

CHECK THE INFORMATION LABEL ON THE CASE TO DETERMINE THE CORRECT VOLTAGE BEFORE CONNECTING TO A LIVE SUPPLY.

CAUTION:

This equipment is designed for installation in an enclosure that provides adequate protection against electric shock. The isolation switch should be located in close proximity to the unit, in easy reach of the operator and appropriately marked.

Power Connections - 24/48V AC/DC Powered Instruments

24/48V AD/DC powered instruments will operate from a 20 to 48V AC or 22 to 55V DC supply. AC power consumption is 15VA max, DC power consumption is 12 watts max. Connection should be via a two-pole IEC60947-1 & IEC60947-3 compliant isolation switch / circuit breaker and a UL listed fuse type: 65v dc 315 mA anti-surge.

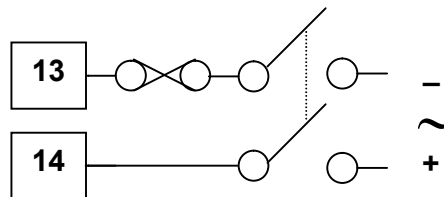

Figure 8. 24/48V AC/DC Power Connections

WARNING:

CHECK THE INFORMATION LABEL ON THE CASE TO DETERMINE THE CORRECT VOLTAGE BEFORE CONNECTING TO A LIVE SUPPLY.

CAUTION:

This equipment is designed for installation in an enclosure that provides adequate protection against electric shock. The isolation switch should be located in close proximity to the unit, in easy reach of the operator and appropriately marked.
Universal Input Connections

Universal Input Connections – Strain Gauge 4/6 Wires Transducer

Input 1

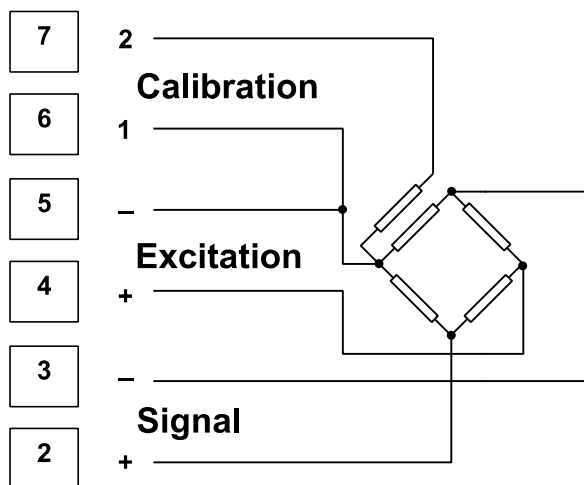

Input 2

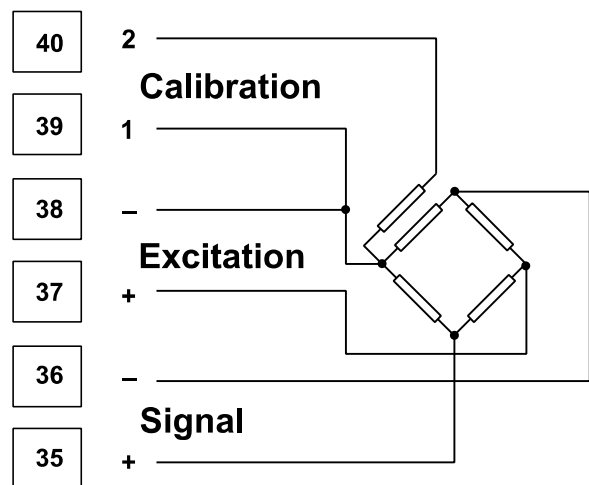

Figure 9. Strain Gauge Input Connections

Universal Input Connections – 4-20mA Two-wire Transmitter Powered by Instrument

24VDC supply is available if and only if Transmitter PSU option card is installed in option 3 slot of the instrument. Please use an external 24VDC power supply if the Transmitter PSU option card is not available.

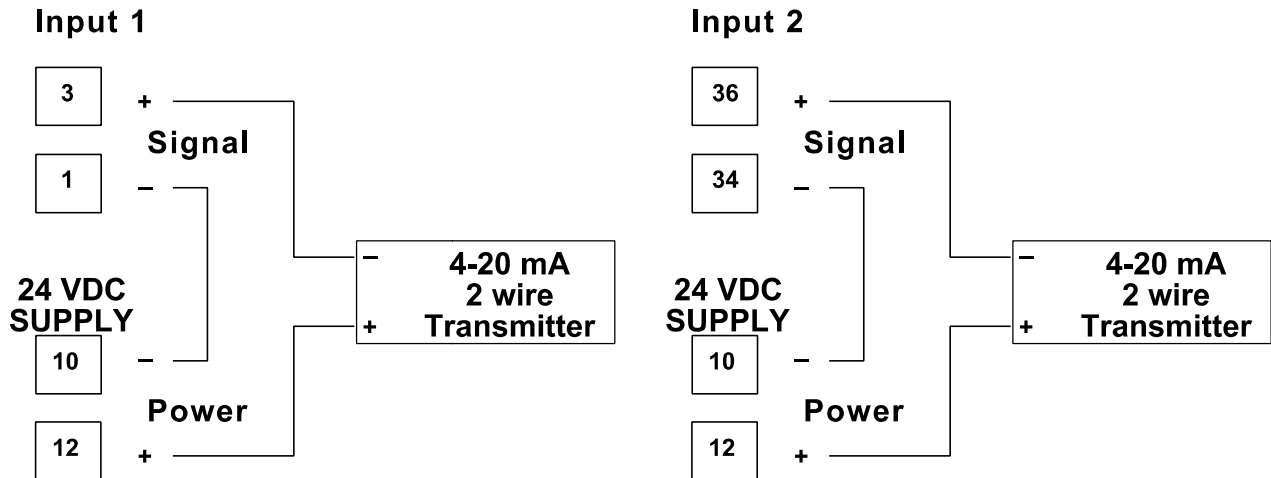

Figure 10. 4-20mA Transmitter Input Connections

Universal Input Connections – 0-5V or 0-10VDC Transmitter Powered by Instrument

24VDC supply is available if and only if Transmitter PSU option card is installed in option 3 slot of the instrument. Please use an external 24VDC power supply if the Transmitter PSU option card is not available.

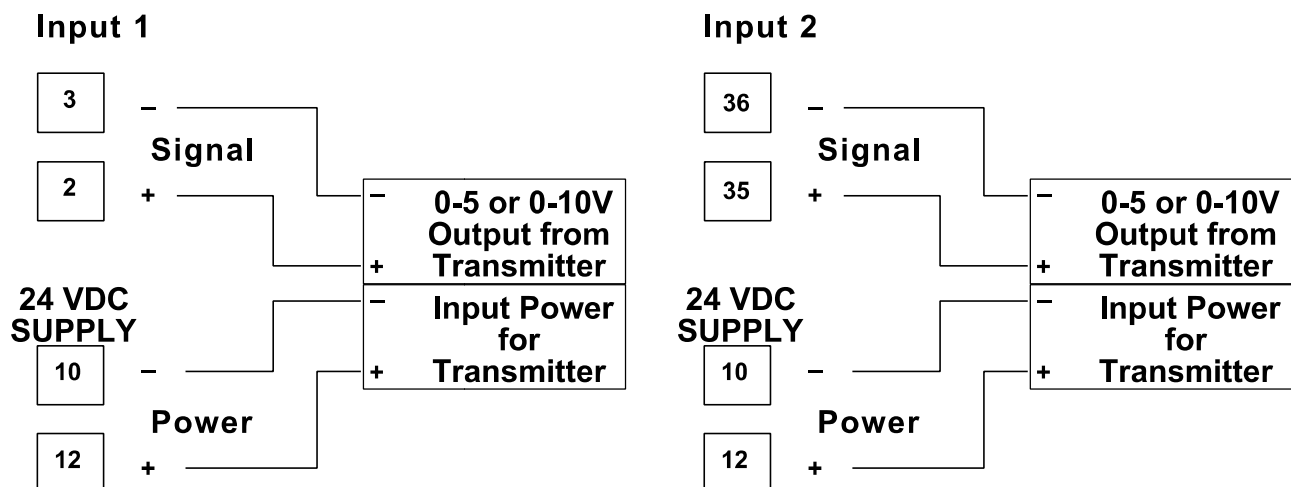

Figure 11. Voltage Transmitter Input Connections

Universal Input Connections - Thermocouple (T/C)

Use only the correct thermocouple wire or compensating cable from the probe to the instrument terminals avoiding joints in the cable if possible. Where joints are made, special thermocouple connectors must be used. Failure to use the correct wire type and connectors will lead to inaccurate readings. Ensure correct polarity of the wires by cross-referencing the colours with a thermocouple reference table.

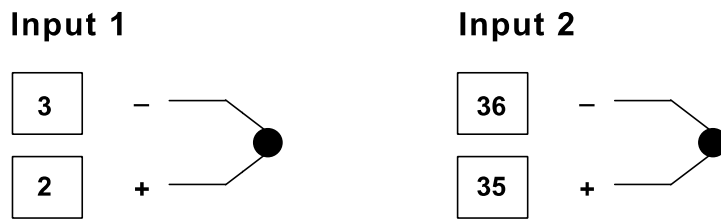

Figure 12. Thermocouple Input Connections

Universal Input Connections – PT100 / NI120 (RTD) input

For three wire RTDs, connect the resistive leg and the common legs of the RTD as illustrated. For a two wire RTD a wire link should be used in place of the third wire (shown by dotted line). Two wire RTDs should only be used when the leads are less than 3 metres long. Avoid cable joints.

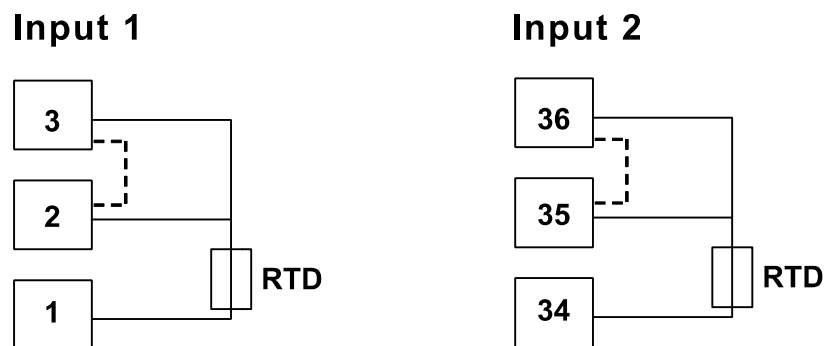

Figure 13. RTD Input Connections

Four wire RTDs can be used, provided that the fourth wire is left unconnected. This wire should be cut short or tied back so that it cannot contact any of the terminals on the rear of the instrument.

Option Slot 1 Connections

Option Slot 1 – Single Relay Output Module

If option slot 1 is fitted with a single relay output module, make connections as illustrated. The relay contacts are SPDT and rated at 2 amps resistive, 240 VAC.

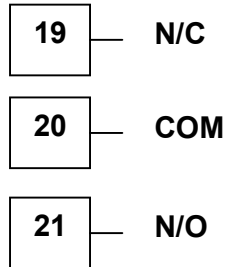

Figure 14. Option Slot 1 – Single Relay Module

Option Slot 1 – SSR Driver Output Module

If fitted with an SSR Driver output module, connect as shown. The 10V DC pulse signal (load resistance ≥ 500 ohms) is isolated from all inputs/outputs except other SSR drivers.

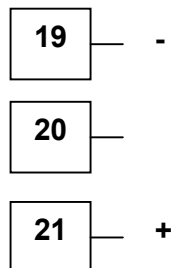

Figure 15. Option Slot 1 – SSR Driver output module

Option Slot 2 Connections

Option Slot 2 – Single Relay Output Module

If option slot 2 is fitted with a single relay output module, make connections as illustrated. The relay contacts are SPDT, and rated at 2 amps resistive, 240 VAC.

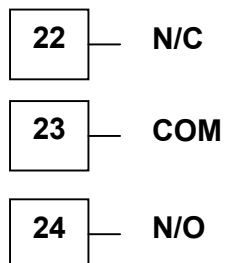

Figure 16. Option Slot 2 – Single Relay Module

Option Slot 2 - Dual Relay Output Module

If option slot 2 is fitted with a dual relay output module, make connections as illustrated. This module has two independent SPST relays, which share a common connection terminal. The contacts are rated at 2 amp resistive 240 VAC.

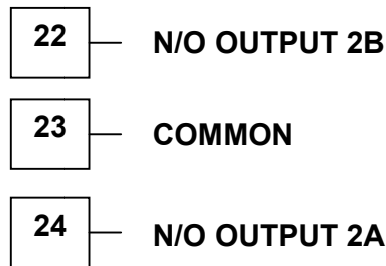

Figure 17. Option Slot 2 - Dual Relay Module

Option Slot 3 Connections

Option Slot 3 – Single Relay Output Module

If option slot 3 is fitted with a single relay output module, make connections as illustrated. The relay contacts are SPDT, and rated at 2 amps resistive, 240 VAC.

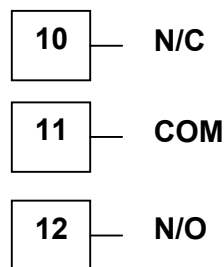

Figure 18. Option Slot 3 – Single Relay Module

Option Slot 3 - Transmitter Power Supply Module

If option slot 3 is fitted with a transmitter power supply module, make connections as illustrated. The output is an unregulated 24V DC, 60mA supply.

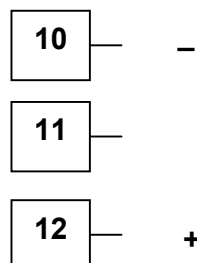

Figure 19. Option Slot 3 - Transmitter Power Supply Module

Option Slot A Connections

Option Slot A Connections - RS485 Serial Communications Module

If option slot A is fitted with the RS485 serial communication module, connections are as illustrated. Carefully observe the polarity of the A (Rx/Tx +ve) and B (Rx/Tx -ve) connections.

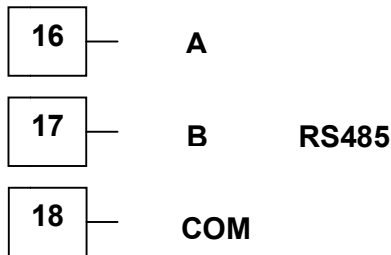

Figure 20. Option Slot A – RS485 Serial Communications Module

If fitted with the Ethernet communication module, the communications protocol available is Modbus TCP. Isolated from all inputs/outputs. If necessary, cut out the removable panel to access the RJ45 connector through the top of the case. No rear connections are required.

CAUTION:

External computing devices connected to the communications port should comply with the standard, UL 60950.

4 Powering Up

CAUTION:

Ensure safe wiring practices have been followed. When powering up for the first time, disconnect the output connections.

The instrument must be powered from a supply according to the wiring label on the side of the unit. The supply will be either 100 to 240V AC, or 24/48V AC/DC powered. Check carefully the supply voltage and connections before applying power.

Powering Up Procedure

At power up, a self-test procedure is automatically started, during which a splash screen is displayed and the LED indicators are lit. At the first power up from new, or if the option modules are changed, the Setup Wizard will run, indicating that configuration is required (*refer to the Setup Wizard section of this manual*). At all other times, the instrument returns to Operation Mode once the self-test procedure is complete.

Front Panel Overview

The illustration below shows the instrument front panel. A USB socket fitted to USB and Data Recorder versions, to the right of the keypad.

Clean the front panel by washing with warm soapy water and dry immediately. If the USB option is fitted, close the USB port cover before cleaning.



Figure 21. Front panel and keys

Display

The instrument has a 160 x 80 pixel monochrome graphical display with dual colour (red/green) backlight. The main display typically shows the process variable, set point/manual power values and a deviation (ATC990) or % of input range bar-graph (UPR900). Other operator displays allow for the enabling of the control, selection of

auto/manual modes, and graphical trends views. Alarm and recorder status may also be displayed.

The top line of the display has labels for the 4 LED indicators. If desired, the backlight colour can be changed to indicate the presence of an active alarm..





LED Functions

There are four red LEDs that by default indicate the pressure control status, automatic tuning and alarm 1 & 2 status (ATC990) or Alarm 1, 2 & 3 Status (UPR900). The top line of the graphical display has four labels for LED indicators. The function of these LEDs and their display labels can be changed using the PC configuration software. The information in this manual assumes standard functions for these LEDs.

Keypad

Each instrument has four keypad switches, which are used to navigate through the user menus and adjust the parameter values. In configuration screens, a context sensitive scrolling help text is displayed that guides the user about the function of the keys.

Table 2. Keypad button functions

Button	Function
	Moves backwards to the previous parameter or screen in the current mode. CAUTION: If editing a parameter, ensure that the current (highlighted) parameter value is correct before pressing the key as this action will update the instrument to the value displayed.
	In menus and configuration choice screens, this key moves to the next item on the list. Editable values can be decreased by pressing this key. Holding the key down speeds up the change. In Trend view this key moves the Cursor Line back through the stored data points
	In menus and configuration choice screens, this key moves to the previous item on the list. Editable values can be increased by pressing this key. Holding the key down speeds up the change. In Trend view this key moves the Cursor Line forward through the stored data points
	Moves forwards to the next parameter or screen in the current mode. CAUTION: If editing a parameter, ensure that the current (highlighted) parameter value is correct before pressing the key as this action will update the instrument to the value displayed.

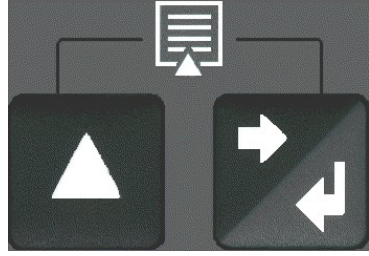

Pressing the X key while holding down the Δ key causes the instrument to move up one menu level. From Operation Mode and in most menus, this will result in entry to the Main Menu. From sub-menus, it is necessary to carry out this sequence more than once to reach the main menu.

CAUTION: If editing a parameter, ensure that the current (highlighted) parameter value is correct before pressing the key as this action will update the instrument to the value displayed.

5 Messages and Error Indications

Start-up Errors

The following displays are shown when an error is detected during the power-up self-test.

Option Module Problems

The “**Option Slot n Error**” display is shown when an error detected with the installed option modules - where “n” is the slot number for the fault.

Replace the module in slot “n”. If this does not solve the problem, return the instrument for servicing.

Configuration Problem

Warns if a problem has been detected with the instrument configuration. Check all settings are correct before proceeding. If the problem persists, return the instrument for servicing.

Input Problems

Sensor Break Detection

Whenever a problem is detected with the process variable or auxiliary input connections, their displayed value is replaced with the word “**OPEN**”.

This may be the result of a failed sensor, a broken connection or an input circuit fault. In this condition, the Control Outputs go to the pre-set power value (*see Control Configuration*).

CAUTION:

Correct the signal/wiring problem to continue normal operation.

Un-Calibrated Input Detection

The instrument is fully calibrated during manufacture. If a fault occurs and the calibration data becomes corrupted, the process input display is replaced with the word “**ERROR**”. In this condition, the Control Outputs go to the pre-set power value (*see Control Configuration*).

CAUTION:

Re-calibrate the input before continuing normal operation. If the problem persists, return the instrument for servicing.

PV Over-range or Under-range Indication

If the measured process variable value is more than 5% above than the Scale Range Upper Limit, its value is replace by the word “**HIGH**”.

If the measured process variable value is more than 5% below than the Scale Range Lower Limit, its value is replace by the word “**LOW**”.

Auxiliary Input Over-range or Under-range Indication

If the auxiliary input (RSP) is more than 5% above than the Auxiliary Input Upper Limit, its value is replaced by the word “**HIGH**”.

If the auxiliary input (RSP) is more than 5% below than the Auxiliary Input Lower Limit, its value is replace by the word “**LOW**”.

If you need to return your instrument for servicing, check the Service Information screen (available from the main menu) or contact your supplier.

USB Data Transfer Problems

Data Transfer Failure message

If the instrument cannot successfully write to the USB memory stick, the message “**Data Transfer Failure**” will be displayed. Check that there is adequate disk space on the memory stick, then retry.

If the instrument cannot successfully read data from the USB memory stick, the message “**Data Transfer Failure**” will also appear. Check that this operation would not cause the maximum number of profiles and/or segments to be exceeded then retry.

6 Configuration and Use

Operation Mode

This is the mode used during normal operation of the instrument. It can be accessed from the Main Menu, and is the usual mode entered at power-up. The available displays are dependent upon the features and options fitted and the way in which it has been configured.

WARNING:

DURING NORMAL USE, THE USER MUST NOT REMOVE THE CONTROLLER FROM ITS HOUSING OR HAVE UNRESTRICTED ACCESS TO THE REAR TERMINALS, AS THIS WOULD PROVIDE POTENTIAL CONTACT WITH HAZARDOUS LIVE PARTS.

CAUTION:

Set all Configuration parameters as required before starting normal operations. It is the responsibility of the installing engineer to ensure that the configuration is safe for the intended application.

Base, & Trend Operating Screens

The Base screen is the usual screen displayed during operation. It provides “at a glance” information about the process. Trend View is a graphical representation of recent process conditions. Its scale adjusts automatically for the best resolution for the visible data.

Note:

Trend data is not retained at power down or if the Sample Interval is changed.

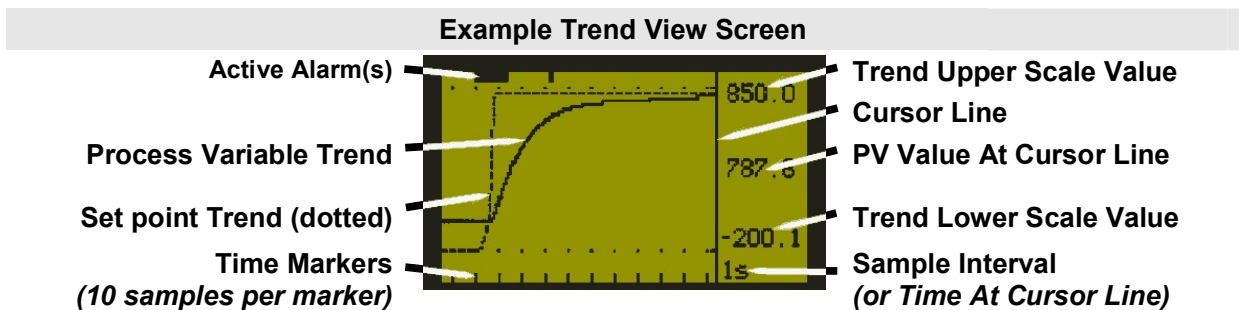
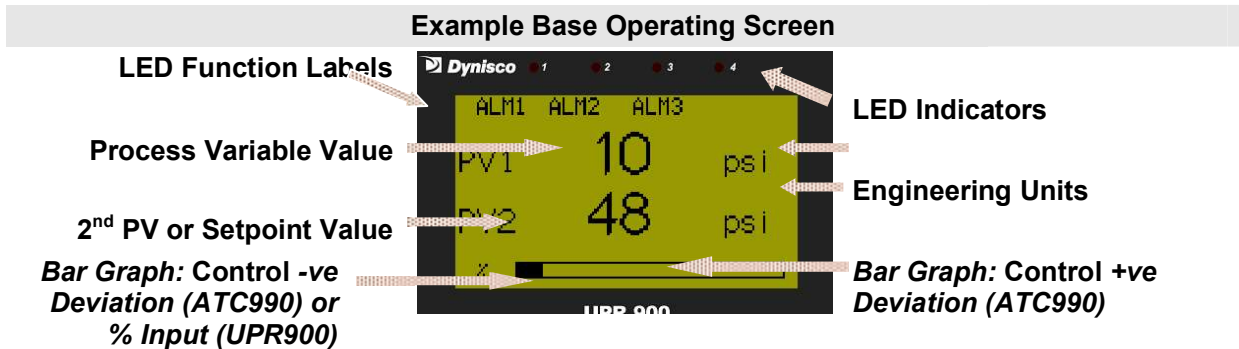













Table 3. Operation Mode Screens

UPR900 Operation Mode:	
After 2 minutes without key activity, the most screens revert to the Base Operating Screen. Screens marked ⌚ do not revert automatically. They remain displayed until the user navigates away.	
Calibration Check Due Warning	⌚ Shown if a Calibration Reminder is set and the due date has passed- <i>if the feature is enabled in Control Configuration. Recorder version only.</i> Shown at power up (and repeated once per day). Press  to acknowledge and continue using the instrument. Re-calibrate or disable the reminder to cancel the warning.
Base Operating Screen. Displayed is: LED Labels; PV1 value; PV2 value & Bar Graph	⌚ LED Labels = LED indicator functions. Defaults are ALM1, ALM2 & ALM3 - can be altered with configuration software PV1 value = The current Process Variable 1 value. PV2 value = The current Process Variable 2 value (<i>if fitted</i>). Bar Graph = % of Process Variable 1 input range.
PV1 & PV1 Peak Value Screen. Displayed is: LED Labels; PV1 value; PV1 Peak value & Bar Graph – Only if input 1 peak detect is enabled	⌚ LED Labels = LED indicator functions. Defaults are STBY, ALM1, ALM2 & TUNE - <i>can be altered with configuration software</i> PV1 value = The current Process Variable 1 value. PV1 peak = The peak (max or min) Process Variable 1 value (<i>press  &  to reset stored value</i>). Bar Graph = % of Process Variable 1 input range.
Start & Stop Data Recording	Manually Stop or Start a new recording. – <i>only shown if Recorder Log Trigger is Operator Start/Stop.</i>
PV1 Trend View	⌚ An auto-scaling trend graph of Process Variable 1 or the Minimum and Maximum value of the Process Variable 1 measured since the last sample. Any active alarm(s) are indicated above the graph. 120 data points are visible. The user can scroll the right hand cursor line back to examine up to 240 data points. The sample interval is set in Display Configuration.
PV2 Trend View	⌚ An auto-scaling trend graph of the Process Variable 2 or the Minimum and Maximum value of the Process Variable 2 measured since the last sample. Any active alarm(s) are indicated above the graph. 120 data points are visible. The user can scroll the right hand cursor line back to examine up to 240 data points. The sample interval is set in Display Configuration – <i>Only if 2nd Input is fitted</i>
Recorder Memory Full Warning	Indicates that the Data Recorder memory is full and that recording has stopped – <i>Only if Recording mode is Record Until Memory Full.</i>
Clear Latched Outputs	Hold down  or  to clear the selected latched output – An output will only reset if the condition that caused it to latch on is no longer present  only shown if an output is configured to latch.
Alarm Status	Shows the status (Active, Inactive or Unused) of the three alarms.



ATC990 Operation Mode:	
After 2 minutes without key activity, the most screens revert to the Base Operating Screen. Screens marked ⌚ do not revert automatically. They remain displayed until the user navigates away.	
Calibration Check Due Warning	⌚ Shown if a Calibration Reminder is set and the due date has passed- <i>if the feature is enabled in Control Configuration Recorder version only.</i> Shown at power up (and repeated once per day). Press ESC to acknowledge and continue using the instrument. Re-calibrate or disable the reminder to cancel the warning.
Base Operating Screen. Displayed is: LED Labels; PV1 value; SP/Man value & Bar Graph	⌚ LED Labels = LED indicator functions. Defaults are STBY, ALM1, ALM2 & TUNE - <i>can be altered with configuration software</i> PV value = The current Process Variable 1 value. SP value = The current Setpoint value (or % Manual Power) Bar Graph = Control Deviation (bi-directional).
PV1 & PV2 Value Screen. Displayed is: LED Labels; PV1 value; PV2 value & Bar Graph – Only if 2nd Input is fitted	⌚ LED Labels = LED indicator functions. Defaults are STBY, ALM1, ALM2 & TUNE - <i>can be altered with configuration software</i> PV1 value = The current Process Variable 1 value. PV2 value = The current Process Variable 2 value (<i>if fitted</i>). Bar Graph = Control Deviation (bi-directional).
PV1 & PV1 Peak Value Screen. Displayed is: LED Labels; PV1 value; PV1 Peak value & Bar Graph – Only if input 1 peak detect is enabled	⌚ LED Labels = LED indicator functions. Defaults are STBY, ALM1, ALM2 & TUNE - <i>can be altered with configuration software</i> PV1 value = The current Process Variable 1 value. PV1 peak = The peak (max or min) Process Variable 1 value (<i>press DOWN & UP to reset stored value</i>). Bar Graph = Control Deviation (bi-directional).
PV1 & Output Value Screen. Displayed is: LED Labels; PV1 value; % Control Output value & Bar Graph	⌚ LED Labels = LED indicator functions. Defaults are STBY, ALM1, ALM2 & TUNE - <i>can be altered with configuration software</i> PV value = The current Process Variable 1 value. Output value = The % Control Output Power. Bar Graph = Control Deviation (bi-directional).
Set point Value Display & Adjustment	View and alter Local Setpoint 1 to any value between the Set point Upper and Lower Limits. View Remote Setpoint. <i>Remote setpoint (if used) is read only.</i>
Select Active Setpoint	Select if Local Setpoint 1 or the Remote Setpoint is to be the active set point. – <i>Remote Setpoint uses the 2nd Input if fitted.</i>
Set point Ramp Rate	Set point Ramp Rate adjustment between 1 and 9999 Display Units per hour or OFF. - <i>only shown if enabled in Control Configuration.</i>
Start & Stop Data	Manually Stop or Start a new recording. – <i>only shown if</i>

Recording		<i>Recorder Log Trigger is Operator Start/Stop.</i>
PV1 Trend View	🕒	An auto-scaling trend graph of Process Variable 1 or the Minimum and Maximum value of the Process Variable 1 measured since the last sample. Any active alarm(s) are indicated above the graph. 120 data points are visible. The user can scroll the right hand cursor line back to examine up to 240 data points. The sample interval is set in Display Configuration.
PV2 Trend View	🕒	An auto-scaling trend graph of the Process Variable 2 or the Minimum and Maximum value of the Process Variable 2 measured since the last sample. Any active alarm(s) are indicated above the graph. 120 data points are visible. The user can scroll the right hand cursor line back to examine up to 240 data points. The sample interval is set in Display Configuration – <i>Only if 2nd Input is fitted</i>
Control Enable		Enables or disables control outputs. When disabled, the unit works normally except the Primary and Secondary Control Outputs are turned off
Auto/Manual Control Mode Selection		Allows switching between automatic and manual control modes.
Alarm Status		Shows the status (Active, Inactive or Unused) of the three alarms.
Recorder Memory Full Warning		Indicates that the Data Recorder memory is full and that recording has stopped – <i>Only if Recording mode is Record Until Memory Full.</i>
Clear Latched Outputs		Hold down  or  to clear the selected latched output – An output will only reset if the condition that caused it to latch on is no longer present  only shown if an output is configured to latch.
Alarm Status		Shows the status (Active, Inactive or Unused) of the three alarms.

Navigating in Operator Mode

Press  to move forward or  to move backwards through the available screens.

When a displayed value can be adjusted, use  or  to change its value.

In Trend View, pressing  or  moves the Cursor Line back through the last 240 data points.

Adjusting the Local Set point

Set points can be adjusted within the limits set by the Set point Upper and Lower Limit parameters in Control Configuration.

Press  to select the Set point Value Display and Adjustment screen

Press  or  to adjust each Local Set point to the required value.

A Remote Set point value cannot be altered from the key pad.

Adjusting the Set point Ramp Rate

The Set point Ramp Rate may be adjusted in the range 0.1 to 9999.0 (in display units per hour) and OFF. When the Set point Ramp Rate is set to Off, set point changes will step immediately to the new value.

Press  to select the Set point Ramp Rate screen

Press  or  to adjust ramp rate to the required value.

Note:

The SETPOINT ramp feature is not available in pressure control mode. It disables the pre-tune facility, and the self-tune facility will calculate new tuning terms only after the SETPOINT has completed the ramp.

Selecting Automatic or Manual Mode

The Auto/Manual selection screen allows operators to select between automatic or manual control. Switching to or from manual mode is made via Bump less Transfer. In Manual mode the Set point display is replaced by a 0 to 100% power output level, labelled “Man”.

Press  to select the Manual Power screen

Press  or  to adjust required power to the required value.

CAUTION:

The Manual Mode power level can be adjusted from 0 to 100% (-100 to +100% for dual control). It is not restricted by the Output Power Limit parameters.

Control Enable or Disable

The Control Enable/Disable screen disables the control. It turns off the control outputs (Primary and Secondary power output levels are set to zero).

Press  to select the Control Enable screen

Press  or  to change between control enable and disable.



CAUTION:

Use with care. The instrument is not able to control the process when control is disabled. The Output Power Lower Limit parameters are also ignored.

Main Menu

This menu is used to access the various features and configuration menus available in the instrument. The available menus are dependent upon the features and options fitted and the way in which it has been configured

Entry into the Main Menu

Holding down  and pressing  from Operation Mode and most other screens will cause the unit to enter the Main Menu. Each time this key press sequence is made, the instrument moves to the next menu level above. Sub-menu levels will require this sequence to be pressed more than once in order to reach the Main Menu.

Navigating the Main Menu

Once in the Main Menu, press  or  to select the required option

Press  to enter the chosen menu.

Scrolling “Help Text” is shown at the bottom of the screens to aid navigation.

Unlock Codes







To prevent unauthorised entry, most modes require a pass-code (1 to 9999) to gain entry. These modes are indicated by the symbol  against their names. The default unlocks code for all modes are 10 and the current codes can be viewed and changed from the Lock Code View in Configuration Mode. For security, users should to change the codes. If the Configuration Mode lock code is lost, refer to the Lock code View section of this manual.

Table 4. Main Menu Screens

Main Menu:	
Operation Mode	Display of the process and set point values, selection/adjustment of the Set points, auto/manual control, alarm/event status, trend view and where available, and data recorder.
 Setup Wizard	Easy, step-by-step parameter setup for simple applications.
 Supervisor Mode	If configured from the PC software, a sub-set of up to 50 Configuration screens can be accessed.
 Configuration Menu	Accesses the sub-menus for Input; Control; Outputs; Alarms; Communications; Recorder; Clock; Display; Lock Codes and Reset To Defaults menus and functions.
 Automatic Tuning	Selection of Pre-Tune, Self-Tune and Auto Pre-Tune.
 USB Menu	Uploading/downloading instrument configuration, and data recordings.
 Recorder Menu	Manually starting, stopping and deleting recordings.
Product Information	Instrument information, including features and options installed.
Service Information	Contact information for service/support etc.

Setup Wizard

An easy Setup Wizard runs automatically at first ever power-up or if whenever a Reset To Defaults is carried out. Users can follow the Wizard screens to setup parameters required for typical applications (*screens marked w in the following Screen Sequence lists are also included in the Setup Wizard*).

A partial Wizard also runs whenever option modules have been changed. The partial wizard only shows parameters affected by the changes made. The Wizard can also be run manually from the Main Menu. Once completed, the Setup Wizard exits to Operation Mode.

Experts or users with more complex applications can select the parameters they wish to set-up from the Configuration Menus instead of using the Wizard.



Manual entry to the Setup Wizard

CAUTION:

Adjustments to these parameters should only be performed by personnel competent and authorised to do so.

The Setup Wizard can be selected from the Main Menu.

Hold down  and press  from to enter the Main Menu.



Press  or  to select Setup Wizard.

Press  to enter the Setup Wizard.

Note:

With the exception of the first ever power-up, entry into this mode is security-protected by the Setup Wizard Lock Code. Refer to the Lock Code View section for more details.

Navigating in the Setup Wizard



Press  to move forward or  to move backwards through the screens.

Press  or  to change the value as required.

Hold down  and press  to return to the Main Menu

Scrolling "Help Text" is shown at the bottom of the screens to aid navigation.

Table 5. Setup Wizard Screens

 Setup Wizard:		
Setup Wizard Unlocking	w	Enter correct code number to access Setup Wizard.
- major screens from Configuration Menu (<i>those marked w</i>)	w	Press  to select each major configuration parameter in turn. Follow on-screen prompts to alter the values.
Setup Wizard Completed	w	Confirms completion of the Setup Wizard. Exits to Operation Mode.

Supervisor Mode

This mode is only available if it has been configured from the PC software. The software is used to copy up to 50 screens from the Configuration Menus to include in Supervisor Mode. The purpose of Supervisor Mode is to allow certain users access to a lock code protected sub-set of the main configuration parameters without providing them with the higher level Configuration Menu unlock code.

Entry into Supervisor Mode

CAUTION:

Adjustments to these parameters should only be performed by personnel competent and authorised to do so.

Supervisor Mode is entered from the Main Menu

Hold down  and press  from to enter the Main Menu.



Press  or  to select Supervisor Mode

Press  to enter the Supervisor Mode.

Note:

Entry into this mode is security-protected by the Supervisor Mode Lock Code. Refer to the Lock Code View section for more details.

Navigating in Supervisor Mode



Press  to move forward or  to move backwards through the screens.

Press  or  to change the value as required.

Hold down  and press  to return to the Main Menu

Scrolling "Help Text" is shown at the bottom of the screens to aid navigation.

Table 6. Supervisor Mode Screens

 Supervisor Mode:	
Supervisor Mode Unlocking	If Supervisor Mode is configured, enter correct code number to continue.
- Supervisor Mode Screens ...	Press  to select each parameter in turn. Follow on-screen prompts to alter the values.

Configuration Menu

This menu can be used as an alternative to the more limited Setup Wizard when the instrument is configured for the first time, or when further changes are required to the instruments characteristics. Configuration contains a number of sub-menus that allow access to all of the available parameters. The correct settings must be made before attempting to use the instrument in an application. Screens marked **w** are also shown in the Easy Setup Wizard.

Entry into the Configuration Menu

CAUTION:

Adjustments to these parameters should only be performed by personnel competent and authorised to do so.

Configuration is entered from the Main Menu

Hold down  and press  from to enter the Main Menu.

Press  or  to select Configuration Menu

Press  to enter the Configuration Menu.

Note:

Entry into this mode is security-protected by the Configuration Menu Lock Code. Refer to the Unlock Code section for more details.

Navigating the Configuration Menu

Configuration contains sub-menus to set-up the Input; Output; Control; Alarm; Communications; Recorder; Display and Lock Codes. There is also an option to return the instrument to its factory default settings.

The correct settings must be made before attempting to use the instrument in an application.

From the Configuration Menu, press  or  to select the required sub-menu.

Press  to enter the sub-menu.

Scrolling "Help Text" is shown at the bottom of the screens to aid navigation.

Note:

Only parameters that are applicable to the hardware and options fitted will be displayed.

Table 7. Configuration Menu Screens

 Configuration Menu:	
Configuration Mode Unlocking	Enter correct code number to access Configuration Mode.
Configuration Options	Select the required Configuration Sub-Menu Option from: Input; Control; Output; Alarm; Communications; Recorder; Clock; Display; Lock Code or Reset To Defaults.

Hierarchy Chart of Configuration Menu:

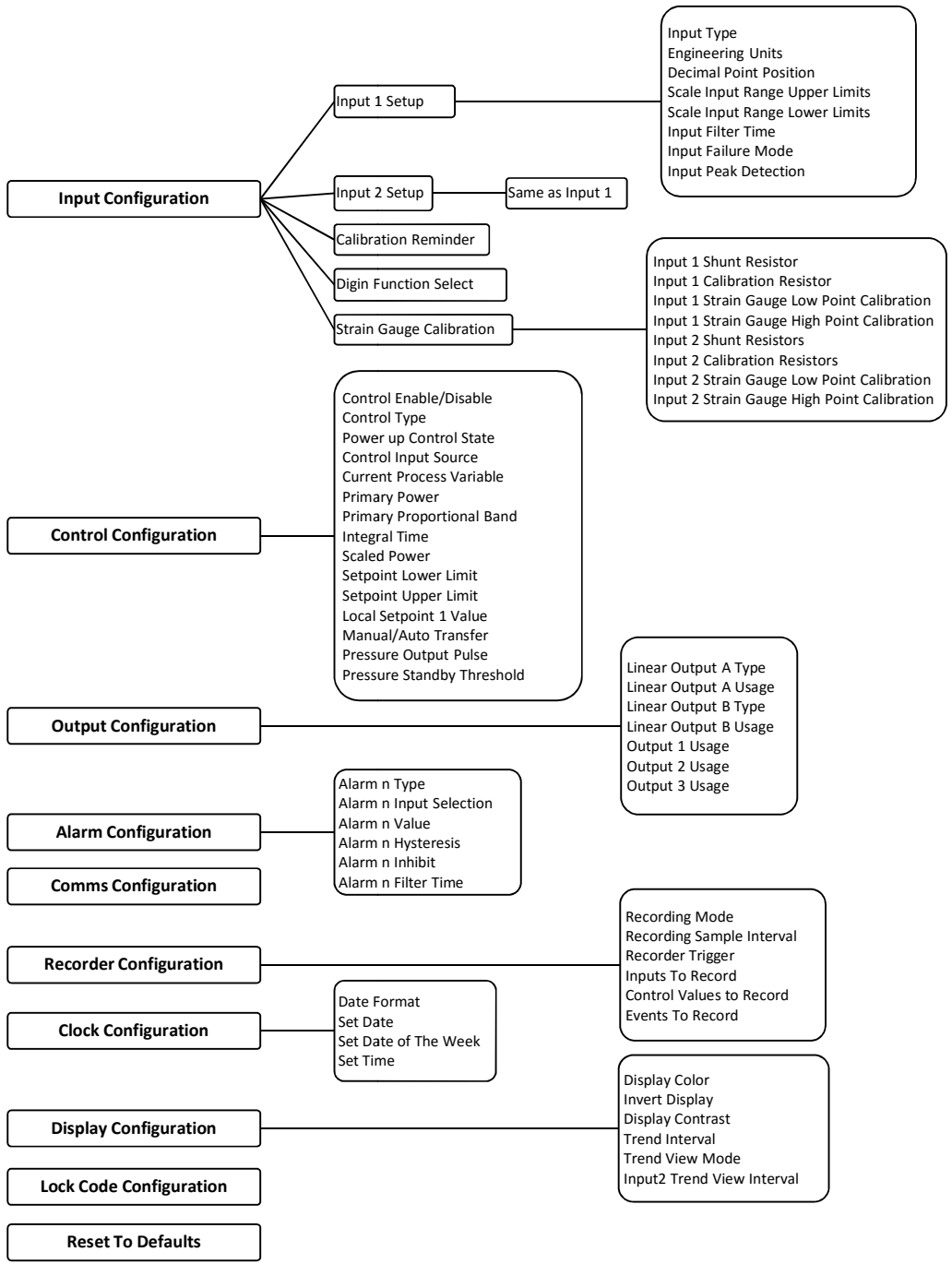

Input Configuration Sub-Menu

Table 8. Input Configuration Sub-Menu Screens

Input 1 Setup:		
Input Type	w	From Strain gauge, various Thermocouple, RTD and Linear inputs. - see specifications section for full details of input types available.
Engineering Units	w	Select display units from: °C; °F; °K; bar; %; %RH; pH; psi, MPa, Kgcm or none.
Decimal Point Position	w	Sets the maximum display resolution to 0; 1; 2 or 3 decimal places. Temperature inputs are limited to 0 or 1 place. Numbers >99.999 never display more than 2 dec places, >999.99 never display more than 1 dec place and >99999 always display without a decimal place.
Scale Range Lower Limit	w	For Temperature inputs, Upper & Lower Limits set the usable span. Min span = 100 units, max span = range limits - see specs. For Linear inputs, Upper & Lower Limits define the values shown (-2000 to 10000) when input is at minimum and maximum values. Min span = 100 units. If Multi-Point Scaling is enabled, up to 15 breakpoints* can scale input vs. displayed value between the linear input scale limits. Adjustable from 0.5 to 100.0 seconds (also OFF isn't possible on ATC/UPR) *A breakpoint set at 100% input ends the sequence.
Scale Range Upper Limit	w	
Input Filter Time		Removes unwanted signal noise. Adjustable from 0.0 (OFF) to 100.0 seconds or OFF (default = 1.0s). Caution: Too large a value will cause slow response to changes in the process. Use with care!
Input Failure Mode		The Input Failure Mode is a safety mechanism that tells the instrument what to do in the event of a loss of the primary signal when in Pressure control mode. If set to Fail High, the control is put in Manual Mode at 0% power and any High alarms are activated. If set to Fail Low, the control is put in Manual Mode at 0% power and any Low alarms are activated.
Input peak Detection		The Peak Detection can be set to Disable, Maximum HIGH, or Minimum LOW. If enabled, the PV1 & PV1 Peak Value Screen will be shown in operator mode. It will display either the highest or lowest PV1 value since reset.

Input 2 Setup:		
Input Type	w	Refer to Input1 Type
Engineering Units	w	Refer to Input1 Engineering Units
Decimal Point Position	w	Refer to Input1 Decimal Point Position
Scale Range Lower Limit	w	Refer to Input1 Scale Range Limit
Scale Range Upper Limit	w	

Input Filter Time	Refer to Input1 Input Filter Time
Input Failure Mode	Refer to Input1 Failure Mode
Calibration Reminder:	
Enable/Disable	Enables or disables the display of Calibration Reminder at start-up (repeated daily thereafter), if the due date has passed – Available on the <i>Recorder version only</i>

Digital Function Select:	
Digital Input n (n=1,2,3 or 4)	Selects from IP1 Peak Reset; IP2 Peak Reset; IP1/2 Peak Reset; Alarm Reset; IP2 Peak & Alarm Reset; IP1/2 Peak & Alarm Reset; IP1 Zero Calibration; IP2 Zero Calibration; IP1/2 Zero Calibration; IP1 Zero Calibration & Alarm & Peak Reset; IP2 Zero Calibration & Alarm & Peak Reset; IP1/2 Zero Calibration & Alarm & Peak Reset; Data Recorder; Auto/Manual Control Select; PID Control Outputs; Run Pre Tune; Run Self Tune; Increment Control Output; Decrement Control Output.

Strain Gauge Calibration:	
Input 1 Shunt Resistor	Enable or disable the Shunt Resistor
Input 1 Calibration Resistor	For transducers with a shunt calibration function (internal or external), the various values must be set. The Shunt Calibration value is a percentage of the full scale transducer range. If the Shunt Value is supplied as a pressure, it must be converted to percent. (<i>value programmable from 40.0 to 100.0%</i> if the Shunt Resistor is enabled)
Input 1 Strain Gauge Low Point Calibration	Zero acquisition phase with strain gauge drained (Zero weight or pressure).
Input 1 Strain Gauge High Point Calibration	Acquisition phase for automatic definition of sensitivity and full-scale, load strain-gauge with reference sample or automatic activation of configured output for 6-wire probe control.
Input 2 Shunt Resistor	Refer to Input 1 Shunt Resistor
Input 2 Calibration Resistor	Refer to Input 1 Calibration Resistor
Input 2 Strain Gauge Low Point Calibration	Refer to Input 1 Strain Gauge Low Point Calibration
Input 2 Strain Gauge High Point Calibration	Refer to Input 1 Strain Gauge High Point Calibration

NOTE:

In this section the word Calibration means to match the Instrument to the input device, so that a specific signal from the input device is equated to a specific pressure and no other, (to the capabilities of its input resolution)

Apply power to the cabinet and allow the system to stabilize for about 30 minutes. Allow the transducer or other input device to come up to operating conditions (i.e. temperature and zero pressure).

Be sure that the full scale and low scale values have been set to match the range of the transducer and that the SHUNT function is ON and set to the correct percentage (80% for a typical Dynisco transducer).

Control Configuration Sub-Menu

Table 9. Control Configuration Sub-Menu Screens

Control Configuration:		
Control Enable/Disable		Sets the method used to enable/disable the control output(s). From: Enabled (<i>always</i>); Disabled (<i>always</i>); Enable/Disable via Digital Inputs, or Operator Selectable (<i>allows control output(s) to be turned off from Operation Mode</i>). Caution: The instrument is not able to control the process when control is disabled. The Output Power Lower Limit parameters are also ignored. Use with care!
Control Type	w	Pressure control(for Strain Gauge and Linear input); Single or Dual control(for Thermocouple/PT100 and Linear input)
Power up Control State		The controller can be set to always power up in manual or automatic mode. Default is manual mode at 0% power. Note: Auto or manual mode can then be selected from the auto/manual control menu, or to immediately go to manual mode from any point, simply press the LEFT & RIGHT keys simultaneously. Caution: In Manual Mode, the user must monitor and alter power to correctly control the process (0 to 100% or -100 to +100% for dual control). Manual power is not restricted by the Output Power Limit parameters. Use with care!
Primary Control Action	w	Set the Primary Control Output for Reverse or Direct Action. Reverse action applies more primary power as the process falls further below set point (e.g. heating applications). Direct action applies more primary power as the process rises further above set point (e.g. cooling applications). If Dual Control is used, the secondary output action is always opposite to the Primary action.
Control Input Source		Selects either Universal Input 1 or Differential Input (Input 1 and Input 2) as the main control input source.
Control Status		Displays the current Process Variable and Set point values to aid manual tuning – <i>This screen is Read Only.</i>
Primary Power		Displays the current Primary control power levels (each 0 to 100%) to aid manual tuning – <i>This screen is Read Only.</i>
Primary Proportional Band		Sets the width of the Primary Proportional Band between 0.1% and 9999.0%, or select On-Off control. – <i>This screen is Read Only during automatic tuning.</i>
Secondary Proportional Band		Sets the width of the Secondary Proportional Band between 0.5% and 999.9%, or select On-Off control. – <i>This screen is Read Only during automatic tuning.</i>
Integral Time (Automatic Reset)		Sets the Integral Time (Automatic Reset) from 1s to 99min 59s or OFF. – <i>This screen is Read Only during automatic tuning.</i>
Derivative Time Constant		Derivative Time Constant (Rate) from 1s to 99 min 59s or OFF. – <i>This screen is Read Only during automatic tuning.</i>
Manual Reset (Bias)		Sets the Manual Reset (Proportional Band Bias) from 0-100% or -100 to +100% for Dual Control.
Overlap / Dead band		Sets the Overlap (+ve values) or Dead band (-ve values) between Primary & Secondary Proportional Bands when Dual Control is used.
Primary On-Off		Sets the Primary On-Off control hysteresis (dead band) from 0.1 to

Differential		10.0% of Span (centred about set point), when Primary On-Off control is used.
Scaled Power		Enables/disables scaling the control output as “RPM” instead of % power.
Scaled Power Lower and Upper Limit		The RPM values to be displayed at 0% power and 100% power (minimum of 100 units between upper and lower value).
Set point Lower Limit		The minimum allowable set point value. Adjustable within the Input Span limits, but must be less than the Set point Upper Limit. Applies to both local and remote set points. Caution: Operators can adjust the set point to any value between the Set point Upper and Lower Limits. Use with care!
Set point Upper Limit		The maximum allowable set point value. Adjustable within the Input Span limits, but must be greater than the Set point Lower Limit. Applies to both local and remote set points. Caution: Operators can adjust the set point to any value between the Set point Upper and Lower Limits. Use with care!
Local Set point 1 Value	w	Sets the value of Local Set point 1 between the Set point Upper and Lower Limits.
Manual/Auto Transfer		When transferring from manual control to Automatic control there are two methods: Bumpless Mode sets the PI power to match previous manual power value, then uses integral to progressively alter power to correct value. Setpoint Mode modifies the Setpoint value to the measured input pressure at switchover. Operator can then change setpoint from the setpoint adjust screen.
Pressure Output Pulse		Enter value output pulse to be applied in Pressure tuning mode. The pulse can be from -25% to +25%. Default is 10%.
Pressure Standby Threshold		The automatic stand-by pressure threshold to switch on the controller automatic stand-by sequence (in physical units from 0 to 15 % of full scale or OFF). Input excursions of [SP± Threshold] start the automatic stand-by. OFF, disables this feature. See Appendix 2-Automatic Stand-by section for more information
Pressure Standby Recovery Time		The maximum time the automatic stand-by sequence is allowed to continue (1 to 60 seconds). If the excursion is longer than this time, manual mode with 0% controller output is applied (emergency stop). See Appendix 2-Automatic Stand-by section for more information
Pressure Standby Active Limit		An active power limitation value. It limits power to the “known good steady state power” required ± the Pressure Stand-by Active Limit value. This improves safety for sensitive processes by avoiding large deflections. See Appendix 2-Automatic Stand-by section for more information

Output Configuration Sub-Menu

Table 10. Output Configuration Sub-Menu Screens

Outputs Configuration:		
Linear Output <i>n</i> Type	w	Set the desired type for any Linear Outputs fitted. From: 0-5, 0-10, 1-5, 2-10V & 0-20, 4-20mA or 0-10VDC power supply (adjustable).
Adjustable 0-10V Power Supply for Output <i>n</i>	w	Sets the voltage required if Linear Output <i>n</i> type is 0-10VDC power supply (adjustable).
Output <i>n</i> Usage	w	Sets the use for each output fitted. From: Unused; Primary/Secondary Control; Retransmit Set point; Retransmit Input 1 or 2. Alarm <i>n</i> Reverse/Direct Acting, Boolean Logical output for Alarms 1,2 or 3. Choices offered are as appropriate for the output type fitted (e.g. only Linear Outputs can retransmit).
Retransmit Output <i>n</i> Scale Low	w	Sets the displayed value at which a retransmission output should be at its minimum level (e.g. the display value when a 4 to 20mA PV Retransmission output will be 4mA. Adjustable from -2000 to 10000).
Retransmit Output <i>n</i> Scale High	w	Sets the displayed value at which a retransmission output will be at its maximum level (e.g. the display value when a 4 to 20mA PV Retransmission output will be 20mA. Adjustable from -2000 to 10000).
Output <i>n</i> Events	w	When an Output Usage is Events & Alarms, this selects which Events(s) will cause it to change state. From: Profile Running or Profile End; Event 1; 2; 3; 4; 5 or a Logical AND of Event <i>n</i> & Alarm <i>n</i> . Each choice is selectable with Direct Action (on during event) or Reverse Action (off during event). - <i>Profiler version only</i>
Output <i>n</i> Latch Enable	w	When an Output Usage is assigned for an Alarm (or Boolean alarm combination), it can be set to Latch. If enabled, the output remains latched ON even if the condition that caused it to be on is no-longer present, and remains latched even if the instrument is powered off-on. The output latch must be reset to turn it off. Note: An output cannot reset if the condition that caused it to turn on is still present.

Alarm Configuration Sub-Menu

Table 11. Alarm Configuration Sub-Menu Screens

Alarm Configuration:		
Alarm <i>n</i> Type	w	Sets the type for each of the 3 alarms From: Unused; Process High; Process Low; PV-SP Deviation; Band; Rate Of Signal Change; PV Signal Break; Control Loop; High Power or Low Power.
Alarm <i>n</i> Input Selection	w	Sets the alarm <i>n</i> linked to Input 1, Input 2 or Differential Input(Input 1&2). – applicable if type is High; Low; (+ve above, -ve below SP), or Rate of Signal Change (a rate of more that <i>x units</i> per hour).
Alarm <i>n</i> Value	w	Alarm activation point. – Applicable if type is High; Low; Deviation

		(+ve above, -ve below SP), Band (above or below SP); %Recorder Memory Used; Rate of Signal Change (a rate of more than x units per hour) or High/Low Power (alarms if control power exceeds this amount).
Process Alarm n Hysteresis		Dead band on "safe" side of alarm, through which signal must pass before alarm deactivates.
Signal change Alarm n Min. Duration	w	Minimum time the rate of PV change must be past the alarm threshold for a Rate Of Change Alarm to change state (on or off). 1.0 to 9999.0 secs
Alarm n Inhibit		Enables or disables the prevention of initial alarm activation, if the alarm condition is true at power up. Activation only occurs once the alarm condition has passed and then reoccurred.
Alarm n Filter Time		The time the alarm value threshold needs to be exceeded before the alarm to activate. From 0.5s to 100s.
Control loop Alarm Type		Select manual Loop alarm time, from 1s to 59min 59s or Automatic (2× integral)
Control Loop Alarm Time		For Manual Loop alarms, enter the time control output must be saturated before alarm activates. From 1s to 59min 59s

Communications Configuration Sub-Menu

Table 12. Communications Configuration Sub-Menu Screens

Communications Configuration:		
No Communications Warning		If Communications Configuration menu is entered without a communications module fitted.
Modbus RTU Parity	w	From: Odd; Even or None.
Modbus RTU Data Rate	w	From: 9600; 19200; 57600 or 115200 bps.
Master Mode, or Slave Address	w	Slave address (1 to 255), or multi-zone Set point Master Mode.
Target Register In Slave		Target register for Set point value in attached slave controllers.
Master Mode Format		The data format required by the attached set point slaves. From: Integer; integer with 1 decimal place or float.
Serial Communications Write Enable		Enables/disables writing via RS485 or Ethernet (if fitted). When disabled, all parameters are read only.

Recorder Configuration Sub-Menu

Table 13. Data Recorder Configuration Sub-Menu Screens

Recorder Configuration:		
No Recorder Warning		If the Recorder Configuration menu is entered on an instrument without this option fitted.

Recording In Progress Warning		If recording in progress when Recorder Configuration entered. – <i>Allows access to the Recording Start/Stop screen only, until the recording is stopped.</i>
Recorder Mode	w	Choose Record Until Memory Used (Stop recording when full) or Continuous FIFO (First In - First Out) - Caution: A FIFO recording will overwrite all previous recordings in memory, starting with the oldest data first. Download the previous data to USB memory stick before selecting this option.
Recording Sample Interval	w	A recording of the selected data will be taken once every Sample Interval. From: Every 1; 2; 5; 10; 15; 30 Seconds, or Every 1; 2; 5; 10; 15; 30 Minutes. Note: Short intervals will reduce the maximum possible duration of the recording.
Recorder Trigger	w	The recording Start/Stop trigger method to be used. From: Operator Start/Stop; Recorder Menu Start/Stop; From Alarm or Digital Input.
Trigger On Alarms		Any combination of the 3 alarms can be set to trigger the recording (TRG) or not (OFF). Any active alarm set to TRG will start the instrument recording. Note: Recording will only stop if all alarms selected as triggers become inactive.
Events To Record		Any combination of the 3 alarms can be recorded and whenever the instrument is powered On/Off. Note: An alarm state change between samples will also be recorded. This uses additional recorder memory, which may cause recorder memory to be exhausted sooner than expected.
Values To Record		Any from: Process Variable value; Maximum or Minimum PV (since the previous sample was taken); Set point; Primary Power or Secondary Power. Any combination of these can be set to Record (REC) or not (OFF). Note: Recording more parameters will reduce the maximum possible duration of the recording.
Recorder Status Information		Shows if a recording is in progress; the recording mode; memory usage per sample; memory remaining and the recording time remaining. The time remaining is adjusted for any alarm/events that have already occurred, but cannot allow for any future alarms/events

Clock Configuration Sub-Menu

Table 14. Internal Clock Configuration Sub-Menu Screens

Clock Configuration:		
Date Format	w	Sets the format used for all displayed dates: <i>dd/mm/yyyy (Day / Month / Year) or mm/dd/yyyy (Month / Day / Year).</i> – <i>Recorder versions only.</i>
Set Date	w	Sets the internal clock Date. – Entered in the format defined by Date Format screen. – <i>Recorder versions only.</i>
Set Day Of Week		Sets the day of week used by the internal clock. – <i>Recorder versions only.</i>

Set Time	Sets the internal clock Time. - In <i>hh:mm:ss (Hours : Minutes : Seconds)</i> format. – <i>Recorder versions only.</i>
-----------------	---

Display Configuration Sub-Menu

Table 15. Display Configuration Sub-Menu Screens

Display Configuration:	
Display Color	From: Red only; Green only; Red to Green on Alarm or Green to Red on Alarm.
Invert Display	Standard or Negative display image.
Display Contrast	Screen contrast (0 and 100) to improve clarity. 100 = maximum contrast.
Trend Interval	Interval between display of next value on the trend graph From: Every 1; 2; 5; 10; 15; 30 Seconds, or Every 1; 2; 5; 10; 15; 30 Minutes.
Trend View Mode	From: PV only, PV (solid) & SP (dotted) at sample time or Max/Min PV between samples (candle-stick graph). Alarm activity is shown above the trend graph.
Input 2 Trend Interval	Interval between display of next value on the Input 2 trend graph From: Every 1; 2; 5; 10; 15; 30 Seconds, or Every 1; 2; 5; 10; 15; 30 Minutes.



Lock Code View

Unlock Codes

To prevent unauthorised entry, some menus are protected by a lock code. These screens are indicated by the  symbol before their names in the screen list tables. To enter these screens, the correct code must first be entered. The current lock codes can be viewed and changed from the Lock Code View Configuration sub-menu.

The default unlock code for all protected menus is 10. For security, users are recommended to change these codes. A value between 1 and 9999 can be used, or the lock can be set to OFF if no protection is required.

Navigating Lock Code View

Press  to move forward or  to move backwards through the screen elements.

Press  or  to change the value as required.

Hold down  and press  to return to the Main Menu

Scrolling “Help Text” is shown at the bottom of the screens to aid navigation.

Table 16. Lock Code View Sub-Menu Screens



Lock Code Configuration:	
Lock Codes	Setup Wizard; Configuration Mode; Tuning Menu; Supervisor Mode; USB and Recorder Menu lock codes (1-9999 or OFF).



Lost Lock Codes



The lock codes can be viewed or changed from Configuration Mode. In the event that the Configuration Mode lock code itself is forgotten, the instrument can be forced into Lock Code View from power-up, where the codes can be checked or set to new values.

Forcing Lock Code View

Power down the instrument.

Re apply the power and hold down  and  for more than 5 seconds as the start-up splash screen appears. Lock Code View will appear.

Press  to move forward or  to move backwards through the screen elements.

Make note of the codes or press  or  to change their values if required.

Hold down  and press  to return to the Main Menu

Scrolling “Help Text” is shown at the bottom of the screens to aid navigation.

Resetting To Defaults

Table 17. Reset To Defaults Sub-Menu Screen

Reset To Defaults:	
Reset To Defaults	Sets all parameters to their factory default values.

If the instrument is to be used in a new or changed application, it is possible to reset all of the instruments parameters back to their factory default settings. The Easy Setup Wizard runs automatically whenever a Reset To Defaults is performed.

CAUTION:

User must reconfigure all required settings before using the instrument in a live application.

Automatic Tuning Menu

The Automatic Tune Menu is used engage the Pre-tune and/or Self-tune facilities to assist the user in setting up Proportional band(s), Integral and Derivative parameter values.

Pre-tune can be used to set PI parameters approximately. Self-tune may then be used to optimise the tuning if required.

Pre-tune can be set to run automatically after every power-up by enabling Auto Pre-Tune.

The **TUNE** indicator (LED 3)* will flash while pre-tune is operating, and is continuously on whilst Self-tune is operating. If both Pre-tune and Self-tune are engaged the **AT** indicator will flash until Pre-tune is finished, and is then continuously on.

Note:



Self-Tune will not engage if either primary or secondary control outputs are set for On-Off control.

Pre-Tune will not engage if either primary or secondary control outputs are set for On-Off control, during set point ramping, if a profile is running or if the process variable is less than 5% of the input span from the set point.

Pressure Pre-Tune can only be engaged when in Pressure Control Mode with Manual Control selected.

Navigating Automatic Tuning Menu

Press  to move forward or  to move backwards through the selections.

Press  or  to engage or disengage the tuning as required.

Hold down  and press  to return to the Main Menu

Scrolling "Help Text" is shown at the bottom of the screens to aid navigation.

*Provided the function of LED3 has not been changed (*LED functions can be altered using the PC Configuration Software*).

Table 18. Automatic Tuning Menus Screens

🔒 Automatic Tuning Menu:		
Automatic Tuning Mode Unlocking		Enter correct code number to access the Automatic Tuning Menu.
Pre-Tune	w	Turns Pre-Tune on/off. Pre-Tune is disabled in On-Off Control Mode; if the PV is less than 5% of span from SP; during Profiles or if the Set point is Ramping.
Pre-Tune Status		Shows the current Pre-Tune status. Active or Inactive.
Run Pressure Pre-Tune		In Pressure mode, this engages the pressure pulse tuning. Only possible from Manual Control
Self-Tune		Turns Self-Tune on/off. Self-Tune is disabled in On-Off Control Mode.
Self-Tune Status		Shows current Self-Tune status. Active or Inactive.
Auto Pre-Tune Enable		Enables/Disables Automatic Pre-Tune. When enabled, this attempts to perform a Pre-Tune at every power-up. Normal Pre-Tune engagement rules are applied (see Pre-Tune above).

USB Menu

A Notification is shown if a USB Memory Stick is inserted or removed from the USB Port. The USB Menu will automatically be offered after insertion. The USB menu can also be accessed from the Main Menu. Refer to the USB Interface section for more details on the use of the USB port option.

Table 19. USB Menu Screens

🔒 USB Menu:		
USB Mode Unlocking		Enter correct code number to access USB Menu.
Read/Write To USB Device?		Select the required action from: Read Instrument Configuration (from USB stick); Write Instrument Configuration (to USB stick) or Write Recorder Log File (to USB stick).
Write	Enter A File or Folder Name	Enter an 8-character folder name for recorder logs, or a file name for configurations or profiles. An extension (.bct for configurations, .pfl for profiles) is added to files automatically. Caution: Existing files/folders with the same name will be over-written.
	Writing Configuration File	An animated screen is shown while the file(s) are being written. Caution: Do not disconnect USB device until completed! Data loss or corruption may result.
	Transfer Successful	Confirmation that the data transfer to the USB stick completed correctly. Press Δ to continue
	Transfer Failure	For write failures, check for adequate disk space on the USB stick.
Read	Select File	Select the Configuration file to transfer from the USB stick. Caution: A configuration read overwrites all existing instrument settings.
	Reading Configuration File	An animated screen is shown while the file is being read. Caution: Do not remove the memory stick whilst this operation is in progress. Data corruption may result.

Transfer Successful	Confirmation that the data transfer from the USB stick completed correctly. Press Δ to continue
Transfer Failure	For read failures, check the maximum number of profiles and/or segments is not being exceeded.

CAUTION:

Do not remove the memory stick from the USB port whilst a Data Transfer to or from the USB stick is in progress. Data loss or corruption may result.

CAUTION:

During Data Transfer, normal operation carries on in the background, but operator access to other screens is not possible. The transfer of a full memory can take up to 7 minutes. Only begin a transfer when you are certain that access (e.g. set point changes) will not be required.

Recorder Control

This menu controls the starting and stopping of the Data Recorder and the deletion of previous recordings. Refer to the Recorder Configuration sub-menu in Configuration Mode for information about how to setup the data to be recorded and the recording interval.

See to the Data Recorder Option section for more details on the use of the recorder and its features.



Table 20. Recorder Menu Screens

🔒 Recorder Control:	
Recorder Mode Unlocking	Enter correct code number to access Data Recorder Menu.
Start/Stop Data Recording	Manually Stop, or Start a new recording. – if Log Trigger is Recorder Menu Start/Stop.
Pause Override Trigger	If recording via digital input or alarm this will pause the recording until Recorder Control is exited.
Recorder Status Information	Shows if a recording is in progress; the recording mode; memory usage per sample; memory remaining and the recording time remaining. The time remaining is adjusted for any alarm or events that have already occurred, but cannot allow for future alarms or events.
Clear Recordings	Clears the recorder memory. Caution: Permanently removes All recorded data.

Product Information Mode

This is a read only mode describing the instrument and the options fitted to it.

Navigating Product Information Mode

Press  to move forward or  to move backwards through the displayed information.

Hold down  and press  to return to the Main Menu

Scrolling “Help Text” is shown at the bottom of the screens to aid navigation.

Table 21. Product Information Screens

Product Information Mode:	
Input Calibration Status	Calibration status of the mVDC, VDC, mADC, RTD and Thermocouple CJC inputs. Caution: Re-calibrate the unit if any inputs are not shown as “Calibrated”.
Calibration Check Due Date	The date re-calibration is due. – Only shown if the Calibration Reminder is enabled in the Input Configuration menu.
Option Slot <i>n</i> Information	The type of Option Modules (if any) fitted in Option Slot s 1 to 4 and A to C.
Controller Feature Information	Shows the features fitted/enabled in the instrument: Controller Only; Shows the features fitted/enabled in the instrument: USB Port; Data Recorder (includes USB Port).
Firmware Information	The type and version of firmware installed in the instrument.
Serial Number	The serial number.
Date of Manufacture	The instrument’s Date of Manufacture

Service Information Mode

This is a read only mode. It provides contact information to the user about where they can obtain service, sales or technical support for the product. Normally this shows either the manufacturer or supplier details. Using the PC software, the user can enter their own details. There are 7 lines of text - each up to 26 characters in length.

Navigating Product Information Mode

There are no other screens in this mode.

Hold down  and press  to return to the Main Menu

Table 22. Service Contact Information Screen

Service Information Mode:	
For Service Contact	Contact information for Service, Sales or Technical Support.

7 USB Interface

The features in this section are available on models fitted with the optional USB Interface.

Using the USB Port

The USB Interface can be used to upload or download instrument settings to or from a USB memory stick (FAT32 formatted). Easy configuration of multiple instruments is achieved by copying from one instrument to another, or by transferring data from the PC configuration software. If the Data Recorder option is fitted, recordings can also be transferred via USB memory stick. *Refer also to the USB menu on page 51.*

USB Memory Stick Folders & Files

When a USB stick is inserted, the instrument looks for, and if necessary creates the **DEVICE**, **CONFIG** and **RECORDER** folders. Files must be located in these folders in order to be used by the instrument. When preparing to upload files from your PC, ensure that you save them to the correct folder on the memory stick.



CAUTION: If the file name already exists, data will be overwritten.

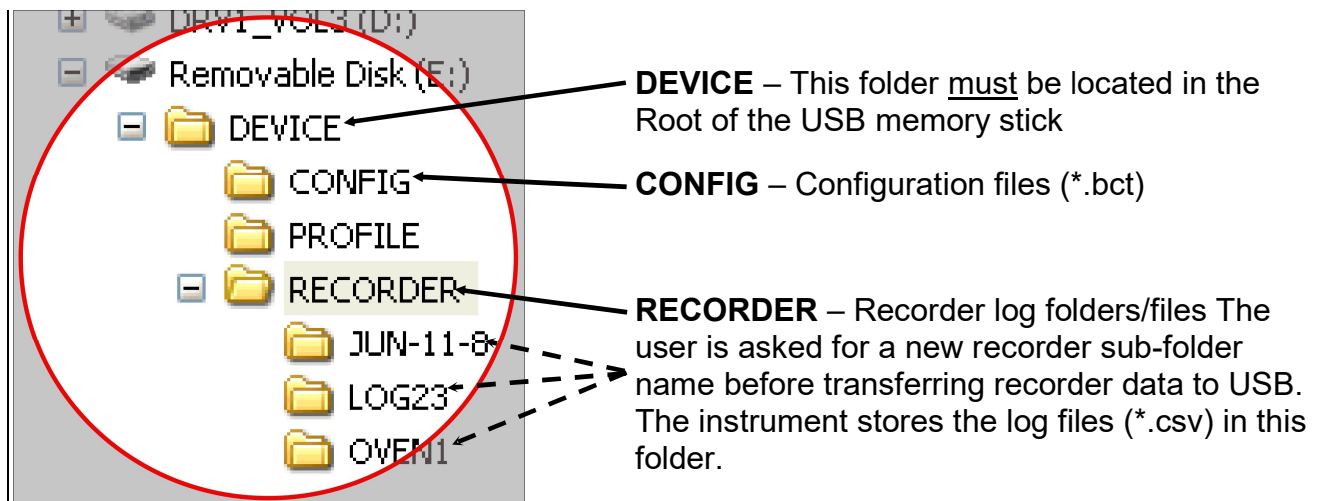

Note: To speed up the disk operation, keep the number of files in these folders to a minimum.

The first recorder log file is named 001-0001.csv. A new file is created with the first 3 digits incremented (e.g. **002-0001.csv**; **003-0001.csv** etc) each time the data being recorded is changed. The last 4 digits increment (e.g. 001-0002.csv; 001-0003.csv etc) if the file size reaches 65535 lines, if a recording is stopped then re-

started or if there is a period of >10s without an alarm when recording from an alarm trigger.



CAUTION: Do not remove the memory stick during data transfer. Data corruption may result.



CAUTION: During data transfer, normal operations carry on in the background, but operator access is denied. Transfer of full memory can take up to 20 minutes. Only begin a transfer when access to the instrument (e.g. setpoint changes) will not be required.

8 Data Recorder

The optional Data Recorder allows the recording of process conditions to memory over time. It operates independently from the Trend Views. The recorder includes 1Mb of flash memory to store data when powered down and a real time clock (RTC) with a battery backup.



CAUTION: Servicing of the Data Recorder/RTC circuit and replacement of the internal lithium battery should be carried out by only a trained technician.

Recordable Values

A selection of values can be recorded for each control loop, from: Process Variable; Maximum or Minimum Process Value (since the previous sample); Setpoint; Primary Power, Secondary Power value. Additionally the status of Alarms can be recorded, as can when the unit is turned On/Off. *See the Recorder Configuration sub-menu.*

Sampling rates between 1 second and 30 minutes are possible, with the data either recorded until all memory is used, or with a continuous “First In/First Out” buffer overwriting the oldest data when full.

The recording capacity is dependent on sample rate and number of values recorded. For example: Two analogue values will be recorded for 21 days at 30s intervals. More values or faster sample rates reduce the duration proportionally.



Note: *If recorded, each alarm change forces an extra sample to be recorded, reducing the remaining recording time available. If these are likely to change often, take this into account when determining if there is sufficient memory available.*

Recorder Control and Status

Options for starting/stopping recordings include **Operator Start/stop**, from the **Recorder Menu**; a **Digital Input**; or **Record on Alarm**. *See the Recorder Configuration sub-menu***Error! Bookmark not defined.**

The recorder control menu allows the manual trigger to be started or stopped, as well as deleting recorded data from memory.

```
Recorder Status: RECORDING
Recording Mode:
Record Until Memory Used
Sample Size:          44b
Memory Remaining: 1046.3kb
Time Remaining:    05:40:35
```

A status screen is shown with current information about the recorder, including if a recording is in progress (Recording or Stopped); the recording mode (FIFO or Record Until Memory Is Used); and the estimated available time remaining based on the data selected and memory used.

Uploading Data

The data is stored in Comma Separated format (.csv) which can be transferred to a memory stick using the USB Port, then opened and analysed with the optional PC software or opened directly into a spreadsheet. Many third party software programs can also import data in the .csv format.

The file contains a header identifying the source instruments serial number, the date of the file upload and descriptions of the data columns.

The data columns seen depends on the data selected to record, but will always include the date and time of each sample. The date format follows the instrument date format selection. Date(en) is dd/mm/yyyy, and Date (us) is mm/dd/yyyy.

	A	B	C	D	E	F	G
1	SerialNumber=00724406-003-010						
2	FileDate=06.08.2013 09:41:09						
3	Date(en)	Time	PV1	Alarm 1 St:	Alarm 2 St:	Alarm 3 St:	Alarm 4 St:
4	01/08/2013	18:33:40	199.76	0	0	0	0
5	01/08/2013	18:33:52	199.8	0	0	0	0
6	01/08/2013	18:34:14	199.84	0	0	0	0
7	01/08/2013	18:34:24	199.88	0	0	0	0
8	01/08/2013	18:34:34	199.92	0	0	0	0
9	01/08/2013	18:34:44	199.96	0	0	0	0
10	01/08/2013	18:34:54	200	0	0	0	0
11	01/08/2013	18:35:04	200.04	0	1	0	0
12	01/08/2013	18:35:14	200.08	0	1	0	0
13	01/08/2013	18:35:24	200.12	0	1	0	0
14	01/08/2013	18:35:34	200.16	0	1	0	0
15	01/08/2013	18:35:44	200.2	0	1	0	0
16	01/08/2013	18:35:54	200.24	0	1	0	0
17	01/08/2013	18:35:58	200.28	0	1	0	0
18	01/08/2013	18:36:08	200.32	0	1	0	0
19	01/08/2013	18:36:18	200.36	0	1	0	0
20	01/08/2013	18:36:28	200.4	0	1	0	0
21	01/08/2013	18:36:38	200.44	0	1	0	0

Calibration Reminder

An additional benefit of the real time clock (RTC) included with the data recorder is the ability to have an input “calibration due” reminder to be shown at a specified date (*see the Input Configuration sub-menu*).

9 Tuning Controllers

9.1 Automatic tuning

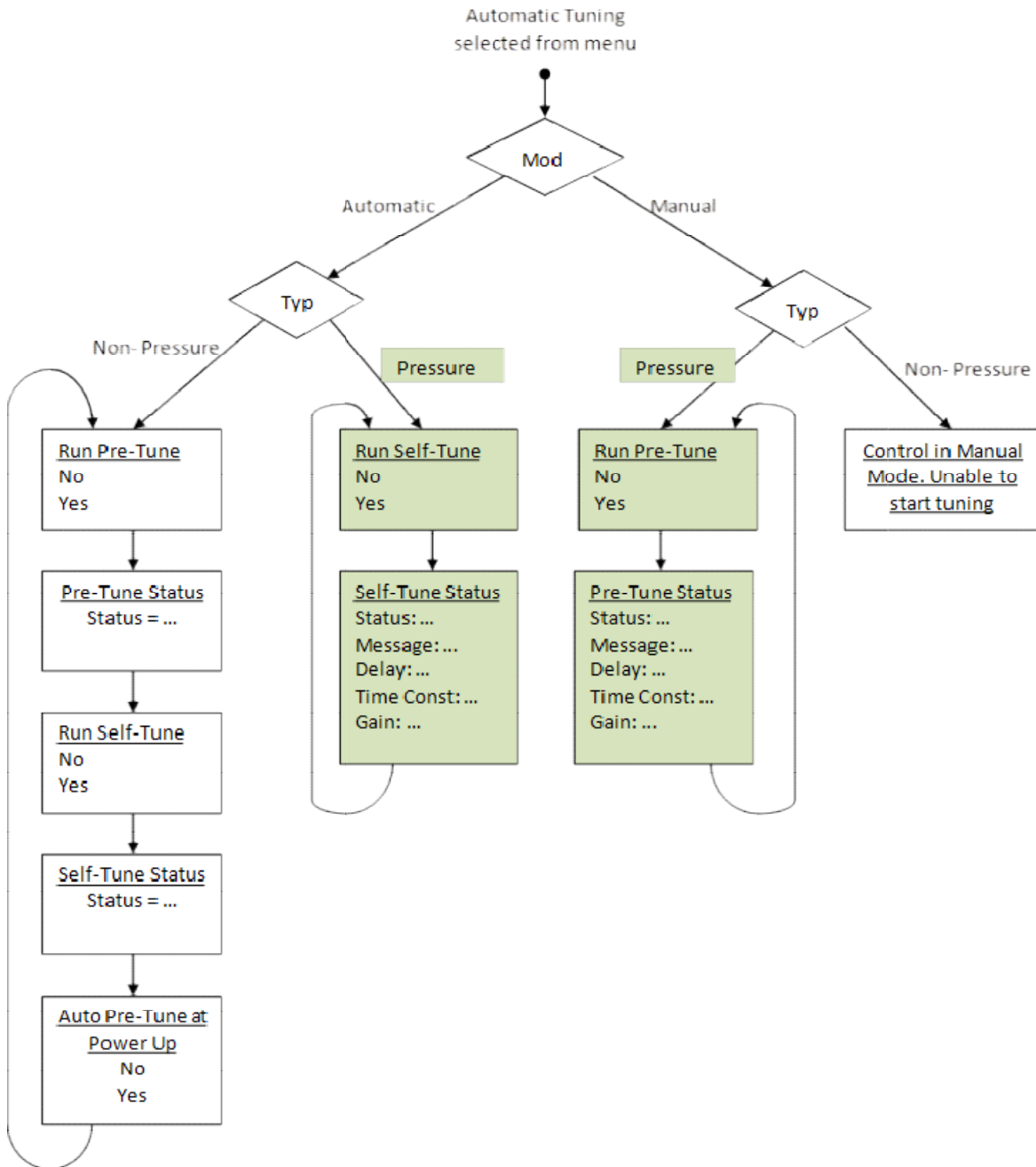



The diagram above shows the automatic tuning options / menus available in the controller. The choices offered are dependent on the instrument mode (Pressure or Non-pressure) and whether the instrument is in Automatic or Manual control mode.

Pressure Mode Automatic Tuning & Operation

Power up the instrument and if in automatic control mode⁽¹⁾, change to manual mode at 0% power/0 RPM⁽²⁾. Set the alarm types and values as required for your application (See alarm configuration).

Set local setpoint 1 as the active setpoint, and its value to the required operating pressure⁽³⁾.

Allow the process to reach operating temperature, then carefully adjust the manual power level (use  and  from the main screen) to bring the process approximately to the operating pressure.

Select the automatic tuning menu, and set “Run Pressure Pre-Tune” to YES.



Press . The Pressure Tune Status screen shows the current status -e.g. “Running”, and The TUNE LED is flashes until the pre-tune is completed.

The instrument adds the defined Pressure Tune Output pulse⁽⁴⁾ to the current manual power level, the process reaction is observed and the instrument calculates and stores the correct PI tuning terms. Pre-tune is now complete and exits.

Automatic control can now be selected, where the control power output level is maintained by the controller. If setpoint mode was selected as the auto/manual transfer method, some adjustment of the setpoint may be required⁽⁵⁾.

Optionally Pressure Self-Tune may be used once in automatic control mode, by selecting the automatic tuning menu, and setting “Run Pressure Self-Tune” to YES⁽⁶⁾. The TUNE LED is lit if Self-tune is enabled.

Notes for Pressure Mode Automatic Tuning & Operation

¹ The initial “power-up control state” can be set to manual or automatic from the control configuration menu, the default is manual mode at 0% power⁽²⁾. Auto or manual mode can be selected from the auto/manual control menu, or to immediately go to manual mode from any point, simply press the  and  simultaneously.

The transition from auto to manual control while running is Bumpless. It takes the last PI power level as the initial manual control power level.

² Manual power can be expressed in % or RPM. For RPM, enable “Scaled Power” in the control configuration menu, then scale 0% and 100% power to their equivalent RPM values.

³ Setpoint Select and the setpoint value screen are in operation mode. Setpoint upper and lower limits can be set in the control configuration menu.

⁴ The Pressure Tune Output pulse value is set in the control configuration menu. The pulse can be from -25% to +25%. Default is 10%.

- 5 The method of transition from manual to automatic control is set in the control configuration menu. Two methods are possible; both ensure a smooth transition to automatic mode:
- a. Bumpless Mode sets the initial PI power level to match the previous manual power value, then uses the integral function progressively alter the power to the correct value.
 - b. Setpoint Mode modifies the current Setpoint value to the measured input pressure value at the time of switchover. The operator can change the setpoint value from the setpoint value screen and the PI control algorithm will adjust the process to this value.
- 6 The self-tune is a continuous, on-line algorithm that "observes" the measured value and looks for oscillation due to load variations or set-point changes. When a significant pattern is recognized the tuning parameters are automatically adjusted.

When Self-tune is running the PI parameters (PB, TI) are read only in the operator menus.

Non-pressure Mode Automatic Tuning & Operation

In non-pressure mode, either Pre-Tune or the Self-Tune algorithm can be activated by selecting from the Automatic Tune selection screen.

Note: Automatic tuning will not engage if either proportional band is set to On/Off control. Also, pre-tune will not engage if the setpoint is ramping or if the Process Variable is <5% of span from setpoint.

1) Non-pressure Pre-Tune

To implement the Pre-Tune algorithm set the instrument in automatic mode and then select Run "Pre-Tune". "Pre-Tune" will switch to OFF after PID parameters calculation (during this procedure the LED will be flashing).

Pre-tune performs a single disturbance of the normal start-up pattern so that a good approximation of the ideal PID values can be made prior reaching setpoint, for this reason the Pre-Tune function may be activated only in automatic mode.

During pre-tune, the controller outputs full primary power until the process reaches the specified test point. Power is then removed (full secondary power applied for dual control), causing an oscillation which the pre-tune algorithm uses to calculate the proportional band(s), integral and derivative time.

2) Non-pressure Self-Tune

To engage the Self-Tune algorithm the instrument must be in automatic mode. Then select run "Self-Tune" in the Automatic Tuning menu.

To deactivate the Self-Tune, deselect run "Self-Tune" in the Automatic Tuning menu.

The self-tune is an on-line algorithm that "observes" the measured value and looks for oscillation due to variations of the load or set-point changes. When a significant pattern is "recognized" a decisional procedure starts in order to recalculate the parameters of PID controller. Successive deviations cause the values to be recalculated converging towards optimal control. When the controller is switched off, these terms are stored and used as starting values at switch on.

Previously stored values may not always be ideal, if for instance the controller is new or the application has changed. In this case the user can use pre-tune to establish new initial values for self-tune to fine-tune.

Self-Tune works best when the tuning terms are approximately correct for the application. Consider running Pre-Tune first before or simultaneously with Self-Tune (Self-Tune is suspended until Pre-Tune completes).

Use of continuous self-tuning is not always appropriate. For example frequent artificial load disturbances, such as where an oven door is often left open for extended periods, might lead to calculation errors. In standard control mode, PI & D are all calculated which may not suit all processes.

When the Self-tune procedure is enabled the PID parameters are read only.

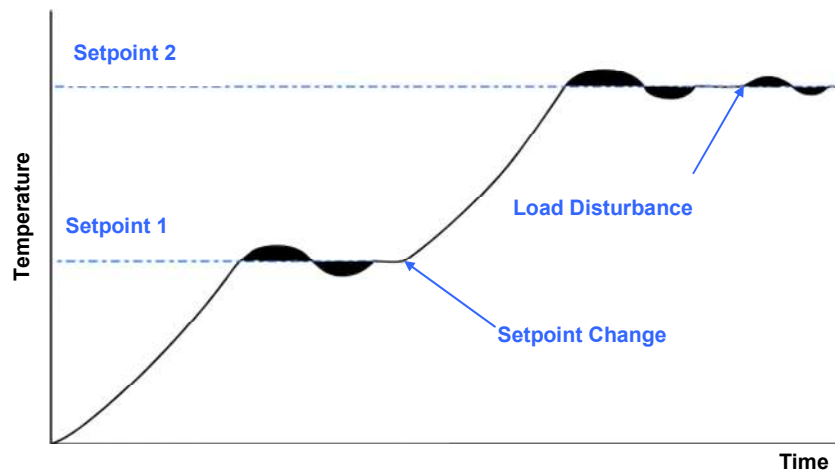

9.2 Manual tuning

Manually Tuning Non-pressure Mode

Tuning Control Loops - PID with Primary Output only

This technique balances the need to reach setpoint quickly, with the desire to limit setpoint overshoot at start-up or during process changes. It determines values for the primary proportional band and the integral and derivative time constants that

allow the controller to give acceptable results in most applications that use a single control device.



CAUTION: This technique is suitable only for processes that are not harmed by large fluctuations in the process variable.

1. Check that the scaled input limits and the setpoint limits are set to safe and appropriate levels for your process. Adjust if required.
2. Set the setpoint to the normal operating value for the process (or to a lower value if an overshoot beyond this value might cause damage).
3. Select On-Off control (i.e. set the primary proportional band to zero).
4. Switch on the process. The process variable will rise above and then oscillate about the setpoint. Record the peak-to-peak variation (P) of the first cycle (i.e. the difference between the highest value of the first overshoot and the lowest value of the first undershoot), and the time period of the oscillation (T) in minutes. See the diagram below.
5. Calculate the PID control parameters (primary proportional band, integral time and derivative time) using the formulas shown.
6. Repeat steps 1-5 for the second control loop if required

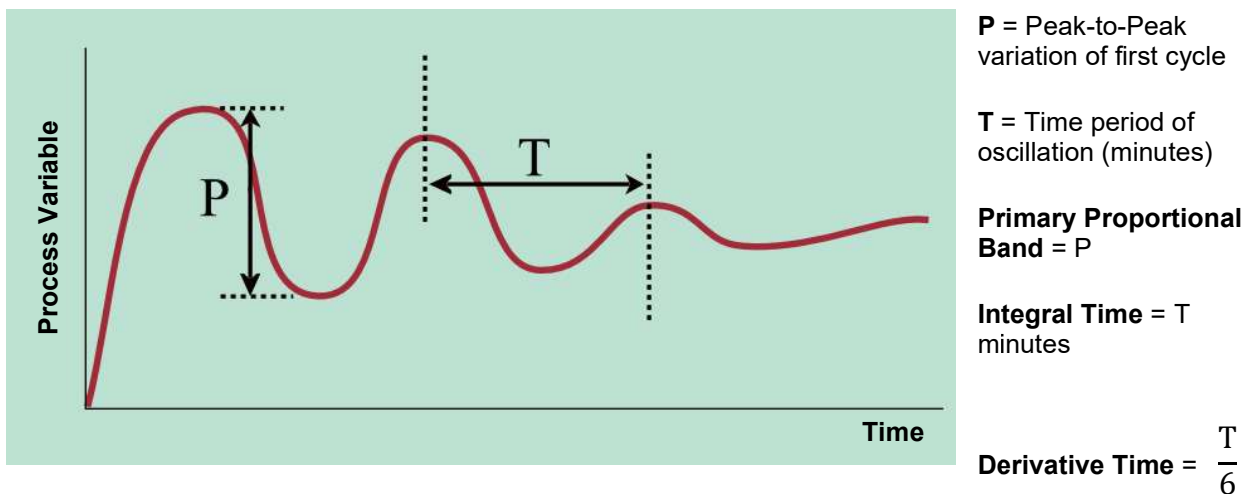

Figure 22. **Manually Tuning - PID with Primary Output**

Tuning Control Loops - PID with Primary & Secondary Outputs

This tuning technique balances the need to reach setpoint quickly, with the desire to limit setpoint overshoot at start-up and during process changes. It determines values for the primary & secondary proportional bands, and the integral and derivative time constants that allow the controller to give acceptable results in most applications using dual control (e.g. Heat & Cool).



CAUTION: These techniques are suitable only for processes that are not harmed by large fluctuations in the process variable.

Method 1 – For Simple Processes

Use this method if the process is simple/easily controlled and the relative power available from the primary and secondary actuators is approximately symmetrical (e.g. if the maximum heating and cooling power is equal)

1. Tune the controller using only the Primary Control output as described in steps 1 to 5 of Manually Tuning - PID with Primary Output, above.
2. Set the Secondary Proportional Band to the same value as the Primary Proportional Band and monitor the operation of the controller in dual control mode.
3. If there is a tendency to oscillate as the control passes into the Secondary Proportional Band, increase its value. If the process appears to be over-damped (slow to respond) in the region of the secondary proportional band, decrease its value.
4. When the PID tuning values have been determined, if there is a disturbance to the process variable as control passes from one proportional band to the other, set the Overlap/Deadband parameter to a positive value to introduce some overlap. Adjust this value by trial and error until satisfactory results are obtained.

Method 2 – For Asymmetrical Processes

Use this method if the relative power available from the primary and secondary actuators is not symmetrical (e.g. if the maximum cooling power is less than the maximum heating power)

1. Check that the scaled input limits and the setpoint limits of the loop in question are set to safe and appropriate levels for your process. Adjust if required.
2. Set the setpoint to the normal operating value for the process (or to a lower value if overshoots beyond this value might cause damage).

3. Select On-Off control by setting the primary proportional band to zero (the secondary proportional band will automatically be set on-off control when you do this).

4. Switch on the process. The process variable will oscillate about the setpoint. Record the peak-to-peak variation (V) of the oscillation (i.e. the difference between the on-going overshoot and undershoot), the time period of the oscillation (T) in minutes and the maximum rate of rise (dP) and fall (dS) as the oscillation continues.

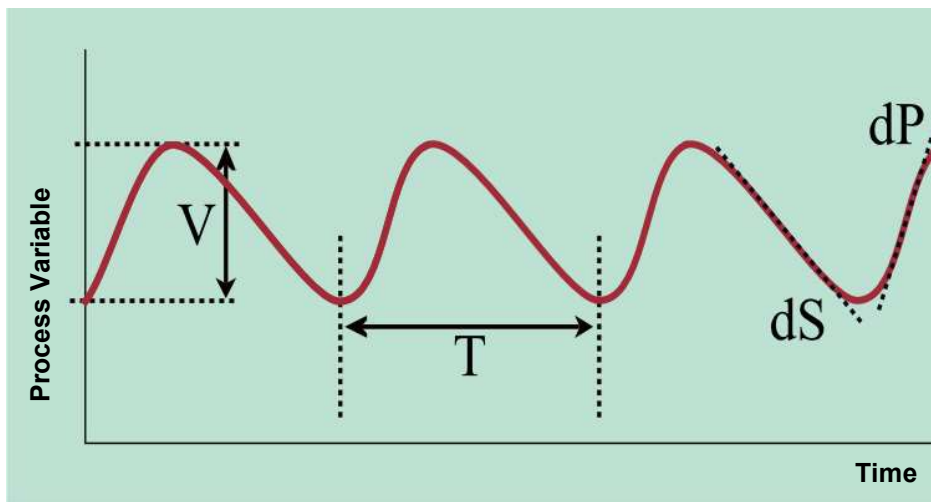

V = On-going Peak-to-Peak variation

T = Time period of oscillation (minutes)

dS = Maximum rate of rise

dP = Maximum rate of fall

R = Ratio $\frac{dS}{dP}$

Primary proportional band = $Pb.P = \frac{V}{R}$

Secondary proportional band = $R \times Pb.P$

Integral Time = T minutes Derivative Time = $\frac{T}{6}$

5. Calculate and enter the PID control parameters (primary proportional band, integral time and derivative time) using the formulas shown, and observe the process.

6. If symmetrical oscillation occurs, increase the proportional bands together, maintaining the same ratio. If the asymmetrical oscillation occurs, adjust the ratio between the bands until it becomes symmetrical, then increase the bands together, maintaining the new ratio.

7. When the PID tuning values have been determined, if there is a disturbance to the process variable as control passes from one proportional band to the other, set the Overlap/Deadband parameter to a small positive value to introduce some overlap. Adjust this value by trial and error to find the minimum value that gives satisfactory results.

Valve / Damper Tuning

This tuning method is used when controlling devices such as dampers or modulating valves with their own valve positioning circuitry. It determines values for the primary proportional band, and integral time constant. The derivative time is normally set to **OFF**. This type of PI Control minimises valve/motor wear whilst giving optimal process control.



CAUTION: This technique is suitable only for processes that are not harmed by large fluctuations in the process variable.

1. Set the setpoint to the normal operating process value (or to a lower value if overshoot beyond this value is likely to cause damage).
2. Set the Primary Proportional Band a value approximately equal to 0.5% of the input span for the loop to be tuned. (*Span is the difference between the scaled input limits*).
3. Set the Integral & Derivative time constants both to OFF.
4. Switch on the process. The process variable should oscillate about the setpoint.
5. Follow the instructions in the diagram below. At each stage, allow sufficient settling time before moving on to the next stage. **P.Pb** is the Primary Proportional Band, **Int.T** is the Integral Time Constant.

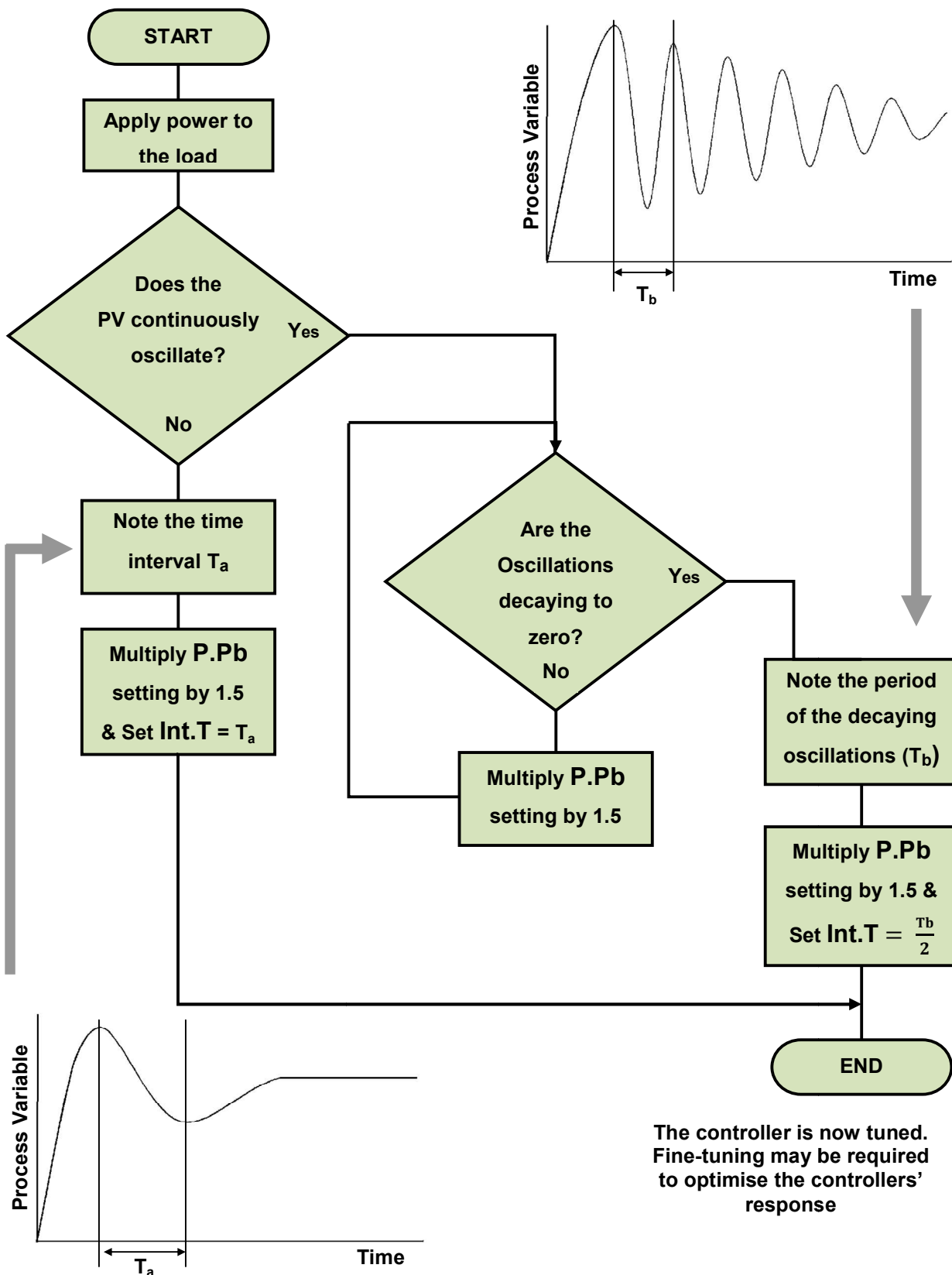

This method can also be used to tune PID loops. Set Derivative to approx. $T_a / 4$

Fine Tuning

Small adjustments can be made to correct minor control problems. These examples assume reverse acting control (e.g. heating). Adjust accordingly for direct action. If they do not help solve the problem, re-tune the controller as detailed on the preceding sections.



Note: *When fine tuning the settings, only adjust one parameter at a time, and allow enough time for the process to settle into its new state each time you change a value.*

Cycle Times

A separate cycle time adjustment parameter is provided for the Primary and Secondary control when using time-proportioning control outputs.

If the process oscillates at the same frequency as the cycle time, it indicates it may be too long for the process. Decrease the cycle time and re-check the period of oscillation, if it has changed to match the new cycle time this confirms that the time is too long.

If the control actuators will accept it, continue reducing the cycle time until the process stabilises, or no further improvement is seen.

Recommended times. Relays ≥ 10 seconds. SSR Driver 1 second.

Proportional Cycle Times

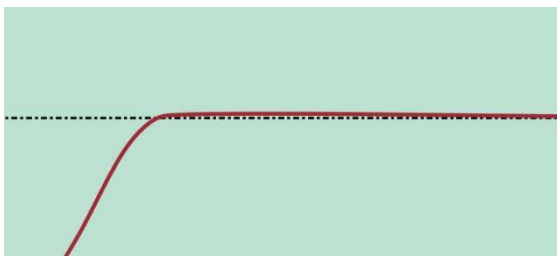

Ideal: Stable Process

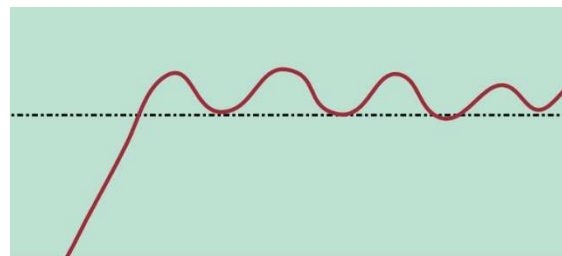

Too Long: Oscillation period = cycle time.



Note: *Adjusting the cycle time affects the controllers operation; a shorter cycle time gives more accurate control, but mechanical control actuators such as relays will have a reduced life span.*

Proportional Bands

Proportional Bands

Increase the width of the proportional bands if the process overshoots or oscillates excessively. Decrease the width of the proportional band if the process responds slowly or fails to reach setpoint.

Proportional Bands

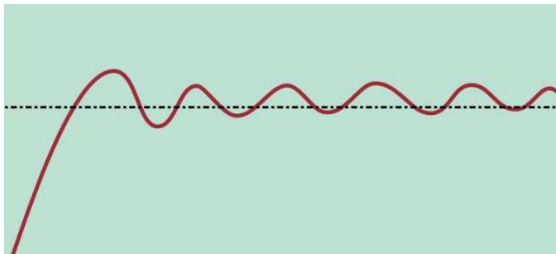

Too Narrow: Process Oscillates

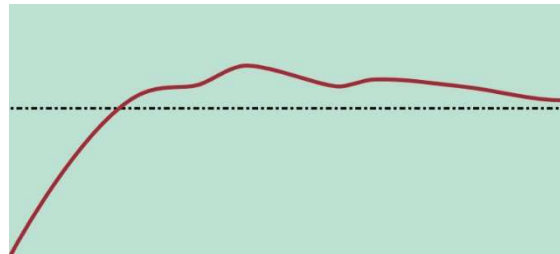

Too Wide: Slow warm up and response

Integral Time Constant

To find the optimum integral time, decrease its value until the process becomes unstable, then increase it a little at a time, until stability has been restored. Induce a load disturbance or make a setpoint change to verify that the process stabilises. If not increase the value some more and re-test. If the response is too slow, decrease the integral time, but avoid instability.

Integral Time

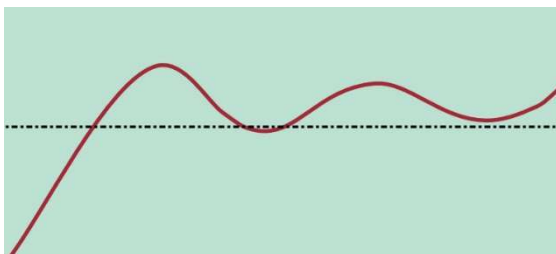

Too Short: Overshoots and oscillates

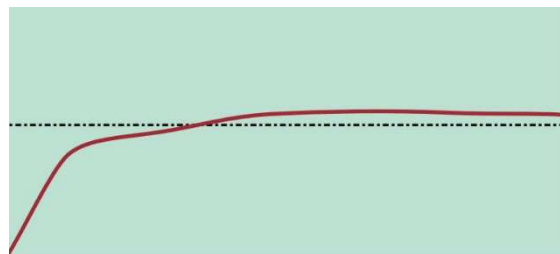

Too Long: Slow warm up and response

Derivative Time Constant

Initially set the derivative to between $1/4^{\text{th}}$ and $1/10^{\text{th}}$ of the Integral time value. Increase the derivative time if the process overshoots/undershoots. Increase it a little at a time, but if the process becomes unstable, decrease it until the oscillation stops. Induce a load disturbance or make a setpoint change to verify that the process stabilises. If not decrease the value some more and re-test.

Derivative Time

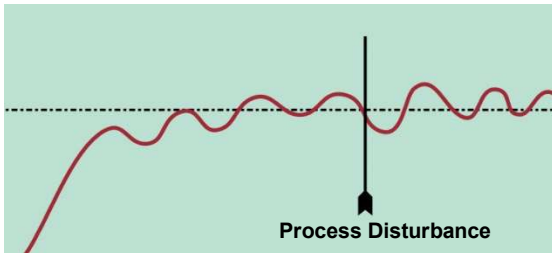

Too Long: Oscillates and over corrects when process disturbed

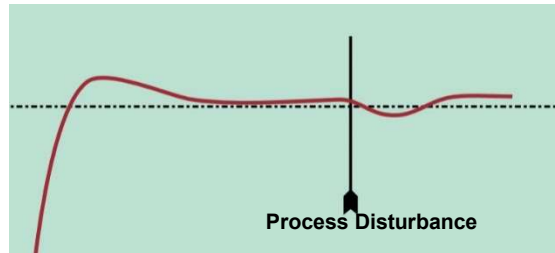

Too Short: Slow warm up and disturbance response under-corrects



Note: When controlling a modulating valve, it is usually recommended that derivative is set to OFF to avoid excessive valve activity. Derivative can cause process instability in these processes.

10 Serial Communications

10.1 Supported Protocols

The unit supports two communication interfaces Modbus RTU and Modbus TCP. Modbus RTU is supported through the RS485 interface and Modbus TCP is supported through the optional Ethernet Module.

For a complete description of the Modbus protocol refer to the description provided at <http://www.modbus.org/>

10.2 RS485 Configuration

The RS485 address, bit rate and character format are configured via the front panel from the Comms Configuration menu.

Physical layer configuration settings possible are:

Data rate:	4800, 9600, 19200, 38400, 57600 or 115200 bps
Parity:	None (default), Even, Odd
Character format:	Always 8 bits per character.
Device Address:	See <i>below</i> .

10.3 RS485 Device Addressing

The instrument must be assigned a unique device address in the range 1 to 255. This address is used to recognise Modbus Queries intended for this instrument. With the exception of globally addressed broadcast messages, the instrument ignores Modbus Queries that do not match the address that has been assigned to it.

The instrument will accept broadcast messages (global queries) using device address 0 no matter what device address is assigned. No response messages are returned for globally addressed Queries.

10.4 Ethernet Configuration

For Modbus TCP communications (Modbus over Ethernet), the IP address can either be assigned by a Dynamic Host Configuration Protocol (DHCP), BootP or AutoIP server on the network, or manually assigned using the IP address allocation software tool.

The supported data rates 10/100BASE-T (10 or 100 Mbps) are automatically detected.

10.5 Link Layer

A Query (or command) is transmitted from the Modbus Master to the Modbus Slave. The slave instrument assembles the reply to the master.

Figure 1. Modbus Link Layer

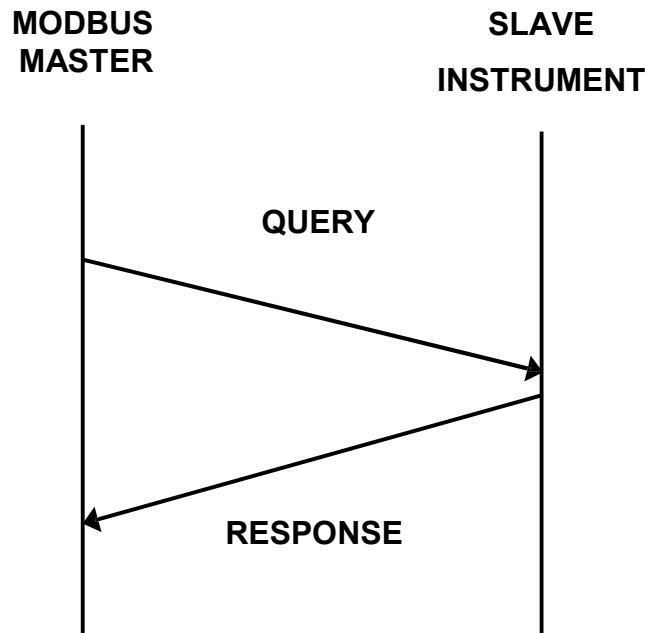

A message for either a QUERY or RESPONSE is made up of an inter-message gap followed by a sequence of data characters. The inter-message gap is at least 3.5 data character times - the transmitter must not start transmission until 3 character times have elapsed since reception of the last character in a message, and must release the transmission line within 3 character times of the last character in a message.

Note:

Three character times is approximately 0.25ms at 115200 bps, 0.51ms at 57600 bps, 0.75ms at 38400 bps, 1.5ms at 19200 bps, 3ms at 9600 bps and 6ms at 4800bps.

Data is encoded for each character as binary data, transmitted LSB first.

For a QUERY the address field contains the address of the slave destination. The slave address is given together with the Function and Data fields by the Application layer. The CRC is generated from the given address, function and data characters.

For a RESPONSE the address field contains the address of the responding slave. The Function and Data fields are generated by the slave application. The CRC is generated from the address, function and data characters.

The standard MODBUS RTU CRC-16 calculation employing the polynomial $2^{16}+2^{15}+2^2+1$ is used.

Inter-message gap	Address 1 character	Function 1 character	Data <i>n</i> characters	CRC Check 2 characters
-------------------	------------------------	-------------------------	-----------------------------	---------------------------

10.6 Supported Modbus Functions

Modbus defines several function types. The following types are supported by this instrument:

Function Code (decimal)	Modbus Meaning	Description
03 / 04	Read Holding/Input registers	Read current binary value of specified number of parameters at given address. Up to 64 parameters can be accessed with one Query.
06	Write Single Register	Writes two bytes to a specified word address.
08	Diagnostics	Used for loopback test only.
16 (0x10 hex)	Write Multiple Registers	Writes up to 253 bytes of data to the specified address range.
23 (0x17 hex)	Read/Write Multiple Registers	Reads and Writes 253 bytes of data to the specified address ranges.

10.7 Function Descriptions

The following is interpreted from the Modbus Protocol Description obtainable from <http://www.modbus.org/>. Refer to that document if clarification is required.

In the function descriptions below, the preceding device address value is assumed, as is the correctly formed two-byte CRC value at the end of the QUERY and RESPONSE frames.

Function 03 / 04 - Read Holding/Input Registers

Reads current binary value of data at the specified word addresses.

QUERY

Function	Address of 1 st Word		Number of Words	
03 / 04	HI	LO	HI	LO

RESPONSE

Function	Number of Bytes	First Word		Last Word	
03 / 04		HI	LO	HI	LO

In the response the "Number of Bytes" indicates the number of data bytes read from the instrument. E.g. if 5 words are read, the count will be 10 (A hex). The maximum number of words that can be read is 64. If a parameter does not exist at one of the addresses read, then a value of 0000h is returned for that word.

Function 06 - Write Single Register

Writes two bytes to a specified word address.

QUERY

Function	Address of Word		Value to write	
06	HI	LO	HI	LO

RESPONSE

Function	Address of Word		Value written	
06	HI	LO	HI	LO

Note:

The Response normally returns the same data as the Query.

Function 08 - Loopback Diagnostic Test

QUERY

Function	Diagnostic Code		Value	
08	HI=00	LO=00	HI	LO

RESPONSE

Function	Sub-function		Value	
08	HI=00	LO=00	HI	LO

Note:

The Response normally returns the same data as the loopback Query. Other Diagnostic Codes are not supported.

Function 16 - Write Multiple Registers (0x10 Hex)

Writes consecutive word (two-byte) values starting at the specified address.

QUERY

Function	1 st Write Address		Number of Words to Write		Number of Query Bytes	1 st Query Byte	2 nd Query Byte	etc	Last Query Byte
10	HI	LO	HI	LO				→	

RESPONSE

Function	1 st Word Address		Number of Words	
10	HI	LO	HI	LO

Note:

The number of data bytes that can be written in one message is 253 bytes.

Function 23 Hex - Read / Write Multiple Registers (0x17 hex)

Reads and writes the requested number of consecutive words (two-bytes) starting at the specified addresses.

QUERY

Function	1 st Read Address		Number of Words to Read		1 st Write Address		Number of Words to Write		Values to Write						
	HI	LO	HI	LO	HI	LO	HI	LO	1 st Word		2 nd Word		etc	Last Word	
17	HI	LO	HI	LO	HI	LO	HI	LO	HI	LO	HI	LO	→	HI	LO

RESPONSE

Function	Number of Bytes	Read Data						
		1 st Word		2 nd Word		etc	Last Word	
17		HI	LO	HI	LO	→	HI	LO

Note:

The number of data bytes that can be read and written in one message is 253 bytes.

Exception Responses

When a QUERY is sent that the instrument cannot interpret, an Exception RESPONSE is returned. Possible exception responses are:

Exception Code	Error Condition	Interpretation
00	Unused	None.
01	Illegal function	Function number out of range.
02	Illegal Data Address	Write functions: Parameter number out of range or not supported. (for write functions only). Read Functions: Start parameter does not exist or end parameter greater than 65536.
03	Illegal Data Value	Attempt to write invalid data / required action not executed.

The format of an exception response is:

RESPONSE

Function	Exception Code
Original Function code with its Most Significant Bit (MSB) set.	<i>as detailed above</i>

Note:

In the case of multiple exception codes for a single QUERY the Exception code returned is the one corresponding to the first parameter in error.

The Modbus parameter register addresses are detailed in the following sections.

The Access column indicates if a parameter is read only (RO) or if it can also be written to (R/W).

Note:

Some parameters that do not apply for a particular configuration will accept reads and writes. Read only parameters will return an exception if an attempt is made to write values to them.

10.8 Data Formats

Data can be read or written in three formats: Integer Only, Integer with 1 Decimal Place and Floating Point Number.

The Modbus Address column shows the register address for each parameter in integer format. Other formats can be calculated from the Integer Only address.

When working in Hexadecimal, the format calculations are:

Address for Integer with 1 Decimal Place = Integer address plus 0x4000
Address for Floating Point = Integer address multiplied by 2, plus 0x8000

When working in Decimal, the format calculations are:

Address for Integer with 1 Decimal Place = Integer address

plus 16384 Address for Floating Point = Integer address

multiplied by 2, plus 32768

Example Register Address Calculations

Calculating Parameter Register Addresses				
		Integer Only	Integer+1	Floating Point
Register Address Calculation	(hex)	Address	Address + 0x4000	Address x 2 + 0x8000
	(dec)	Address	Address + 16384	Address x 2 + 32768
Address Example: (For Process Variable)	(hex)	0x0407	0x4407	0x880E
	(dec)	1031	17415	34830
Data Value Returned: If Actual Value = 23.9 decimal	(hex)	0x00, 0x17	0x00, 0xEF	0x41, 0xBF, 0x33, 0x33
	(dec)	23	239	23.9 as floating decimal
Address Example: (For Selected Setpoint)	(hex)	0x101F	0x501F	0xA03E
	(dec)	4127	20511	41022
Data Value Returned: If Value=1 (Alternative SP)	(hex)	0x00, 0x01	0x00, 0x0a	0x3F, 0x80, 0x00, 0x00
	(dec)	1	10	1.0 as floating decimal

Input 1 parameters

Parameter Name	Modbus Address (Dec)	Modbus Address (Hex)	Access R/W	Notes	Default	
Input Range	1024	0x0400	R/W	Value	Range	37
				0	B TC	
				2	C TC	
				4	D TC	
				6	E TC	
				8	J TC	
				10	K TC	
				12	L TC	
				14	N TC	
				16	R TC	
				18	S TC	
				20	T TC	
				22	P24	
				24	Pt100	
				26	NI120	
				28	0_20mA	
				29	4_20mA	
				30	0_50mV	
				31	10_50mV	
32	0_5V					
33	1_5V					
34	0_10V					
35	2_10V					
36	Potentiometer					
37	Strain gauge					
Engineering units	1025	0x0401	R/W	0 = None 1 = Degrees C 2 = Degrees F 3 = Degrees K 4 = Bar 5 = pH 6 = Percent 7 = Percent RH 8 = PSI 9 = MPa 10 = KGcm	8	
Decimal Place	1026	0x0402	R/W	0 = 1234 1 = 123.4 2 = 12.34 3 = 1.234	0	

Process Input Range Minimum	1027	0x0403	R/W		0
Process Input Range Maximum	1028	0x0404	R/W		10000
Process Input Process variable offset	1029	0x0405	R/W	Span of the input range	0
Process Input Filter time constant	1030	0x0406	R/W	Any value between 0.0 and 512.0	1
Process Input Process Variable	1031	0x0407	R		
Process Input Sensor Break Flag	1032	0x0408	R	0 = Inactive 1 = Active	
Process Input Under Range Flag	1033	0x0409	R	0 = Inactive 1 = Active	
Process Input Over Range Flag	1034	0x040A	R	0 = Inactive 1 = Active	
Process Input CJC Enable	1035	0x040B	R/W	0 = Enable 1 = Disabled	0
Multi-point scaling enable	1053	0x041D	R/W	0 = Disabled 1 = Enabled (Can only be set to enable if the input type is linear)	0
Scale point 1	1054	0x041E	R/W	0.1 to 100.0%	100
Display point 1	1055	0x041F	R/W	Span of the input range	1000
Scale point 2	1056	0x0420	R/W	Scale point 1 to 100.0% can only be set when Scale point 1 is not equal to 100.0%	100
Display point 2	1057	0x0421	R/W	Span of the input range	1000
Scale point 3	1058	0x0422	R/W	Scale point 2 to 100.0% can only be set when Scale point 2 is not equal to 100.0%	100
Display point 3	1059	0x0423	R/W	Span of the input range	1000
Scale point 4	1060	0x0424	R/W	Scale point 3 to 100.0% can only be set when Scale point 3 is not equal to 100.0%	100

Display point 4	1061	0x0425	R/W	Span of the input range	1000
Scale point 5	1062	0x0426	R/W	Scale point 4 to 100.0% can only be set when Scale point 4 is not equal to 100.0%	100
Display point 5	1063	0x0427	R/W	Span of the input range	1000
Scale point 6	1064	0x0428	R/W	Scale point 5 to 100.0% can only be set when Scale point 5 is not equal to 100.0%	100
Display point 6	1065	0x0429	R/W	Span of the input range	1000
Scale point 7	1066	0x042A	R/W	Scale point 6 to 100.0% can only be set when Scale point 6 is not equal to 100.0%	100
Display point 7	1067	0x042B	R/W	Span of the input range	1000
Scale point 8	1068	0x042C	R/W	Scale point 7 to 100.0% can only be set when Scale point 7 is not equal to 100.0%	100
Display point 8	1069	0x042D	R/W	Span of the input range	1000
Scale point 9	1070	0x042E	R/W	Scale point 8 to 100.0% can only be set when Scale point 8 is not equal to 100.0%	100
Display point 9	1071	0x042F	R/W	Span of the input range	1000
Scale point 10	1072	0x0430	R/W	Scale point 9 to 100.0% can only be set when Scale point 9 is not equal to 100.0%	100
Display point 10	1073	0x0431	R/W	Span of the input range	1000
Scale point 11	1074	0x0432	R/W	Scale point 10 to 100.0% can only be set when Scale point 10 is not equal to 100.0%	100
Display point 11	1075	0x0433	R/W	Span of the input range	1000
Scale point 12	1076	0x0434	R/W	Scale point 11 to 100.0% can only be set when Scale point 11 is not equal to 100.0%	100
Display point 12	1077	0x0435	R/W	Span of the input range	1000
Scale point 13	1078	0x0436	R/W	Scale point 12 to 100.0% can only be set when Scale point 12 is not equal to 100.0%	100
Display point 13	1079	0x0437	R/W	Span of the input range	1000
Scale point 14	1080	0x0438	R/W	Scale point 13 to 100.0% can only be set when Scale point 13 is not equal to 100.0%	100
Display point 14	1081	0x0439	R/W	Span of the input range	1000
Scale point 15	1082	0x043A	R/W	Scale point 14 to 100.0% can only be set when Scale point 14 is not equal to 100.0%	100
Display point 15	1083	0x043B	R/W	Span of the input range	1000
Input failure Mode	1096	0x0448	R/W	0 = Fail High 1 = Fail Low	0

Input Peak Detection	1097	0x0449	R/W	0 = Disabled 1 = Maximum Peak 2 = Minimum Peak	0
Peak Value	1101	0x044D	R/W		
Input 1 User Calibration (non Strain Gauge Types)					
Process Input User Calibration Type	1085	0x043D	R/W	0 = No User Calibration 1 = Single Point Calibration 2 = Two Point Calibration	0
Process Input Low Temperature Calibration Point	1086	0x043E	R/W		0
Process Input Low Calibration Offset	1087	0x043F	R/W		0
Process Input High Temperature Calibration Point	1088	0x0440	R/W		2192.5
Process Input High Calibration Offset	1089	0x0441	R/W		0
Input 1 Strain Gauge User Calibration					
Shunt Resistor	1090	0x0442	R/W	0 = Disabled 1 = Enabled	1
Calibration Resistor	1091	0x0443	R/W	40 – 100% of transducer full scale	80
Calibration start	1092	0x0444	R/W	Write 51966 (0xCAFE) to begin the selected calibration attempt	0
Calibration Status	1093	0x0445	R	Returns latest calibration status for Input 1: 0 = None 1 = Busy 2 = Wait Lo 3 = Wait Hi 4 = Complete 5 = CNT Fail 6 = RCAL Fail	0
Calibration mode	1094	0x0446	R/W	Write 1 to Select Input 1 Low Calibration Write 2 to Select Input 1 High Calibration	NA
<p>Each calibration stage requires two Modbus writes. The first tells the unit which input you want to calibrate and if this is to be the Low or High calibration. The second is a password that tells the unit to execute the calibration attempt.</p> <p><u>To perform Strain Gauge Calibration on Input 1</u></p> <p>1. Write "1" to register 1094 <i>Selects Low Calibration</i></p>					

2. Write "51966" to register 1092 *Calibration is attempted*
3. Write "2" to register 1094 *Selects High Calibration*
4. Write "51966" to register 1092 *Calibration is attempted*

It is advisable to read the status between the low and high calibration stages to ensure low cal has completed successfully before performing the high cal

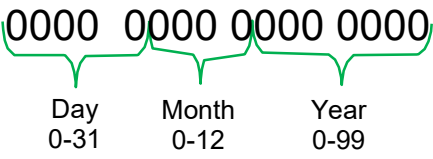
Calibration Reminder					
Calibration Reminder Enable	1048	0x0418	R/W		0
Calibration Reminder Date	1049	0x0419	R/W	Binary coded decimal (BCD) 16 bits that represent the date as follows: XXXX XXXX XXXX XXXX  So an example of setting the date to 31/07/2012 Day = 31 = 11111 Month = 7 = 0111 Year = 12 = 0001100 This would give the total BCD of: 11111 0111 0001100 or 64396. However reading this back out afterwards would return 195468 as the calculated day of	2176

Input 2 parameters

Parameter Name	Modbus Address (Dec)	Modbus Address (Hex)	Access R/W	Notes		Default
				Value	Range	
Input Range	1110	0x0456	R/W	0	B TC	37
				2	C TC	
				4	D TC	
				6	E TC	
				8	J TC	
				10	K TC	
				12	L TC	
				14	N TC	
				16	R TC	
				18	S TC	
				20	T TC	
				22	P24	
				24	Pt100	

				<table border="1"> <tbody> <tr><td>26</td><td>NI120</td></tr> <tr><td>28</td><td>0_20mA</td></tr> <tr><td>29</td><td>4_20mA</td></tr> <tr><td>30</td><td>0_50mV</td></tr> <tr><td>31</td><td>10_50mV</td></tr> <tr><td>32</td><td>0_5V</td></tr> <tr><td>33</td><td>1_5V</td></tr> <tr><td>34</td><td>0_10V</td></tr> <tr><td>35</td><td>2_10V</td></tr> <tr><td>36</td><td>Potentiometer</td></tr> <tr><td>37</td><td>Strain gauge</td></tr> </tbody> </table>	26	NI120	28	0_20mA	29	4_20mA	30	0_50mV	31	10_50mV	32	0_5V	33	1_5V	34	0_10V	35	2_10V	36	Potentiometer	37	Strain gauge	
26	NI120																										
28	0_20mA																										
29	4_20mA																										
30	0_50mV																										
31	10_50mV																										
32	0_5V																										
33	1_5V																										
34	0_10V																										
35	2_10V																										
36	Potentiometer																										
37	Strain gauge																										
Engineering units	1111	0x0457	R/W	0 = None 1 = Degrees C 2 = Degrees F	8																						
Decimal Place	1112	0x0458	R/W	0 = 1234 1 = 123.4 2 = 12.34 3 = 1.234	0																						
Process Input Range Minimum	1113	0x0459	R/W		0																						
Process Input Range Maximum	1114	0x045A	R/W		10000																						
Process Input Process variable offset	1115	0x045B	R/W	Span of the input range	0																						
Process Input Filter time constant	1116	0x045C	R/W	Any value between 0.0 and 512.0	1																						
Process Input Process Variable	1117	0x045D	R																								
Process Input Sensor Break Flag	1118	0x045E	R	0 = Inactive 1 = Active																							
Process Input Under Range Flag	1119	0x045F	R	0 = Inactive 1 = Active																							
Process Input Over Range Flag	1120	0x0460	R	0 = Inactive 1 = Active																							
Process Input CJC Enable	1121	0x0461	R/W	0 = Enable 1 = Disabled	0																						
Multi-point scaling enable	1139	0x0473	R/W	0 = Disabled 1 = Enabled (Can only be set to enable if the input type is linear)	0																						

Scale point 1	1140	0x0474	R/W	0.1 to 100.0%	100
Display point 1	1141	0x0475	R/W	Span of the input range	1000
Scale point 2	1142	0x0476	R/W	Scale point 1 to 100.0% can only be set when Scale point 1 is not equal to 100.0%	100
Display point 2	1143	0x0477	R/W	Span of the input range	1000
Scale point 3	1144	0x0478	R/W	Scale point 2 to 100.0% can only be set when Scale point 2 is not equal to 100.0%	100
Display point 3	1145	0x0479	R/W	Span of the input range	1000
Scale point 4	1146	0x047A	R/W	Scale point 3 to 100.0% can only be set when Scale point 3 is not equal to 100.0%	100
Display point 4	1147	0x047B	R/W	Span of the input range	1000
Scale point 5	1148	0x047C	R/W	Scale point 4 to 100.0% can only be set when Scale point 4 is not equal to 100.0%	100
Display point 5	1149	0x047D	R/W	Span of the input range	1000
Scale point 6	1150	0x047E	R/W	Scale point 5 to 100.0% can only be set when Scale point 5 is not equal to 100.0%	100
Display point 6	1151	0x047F	R/W	Span of the input range	1000
Scale point 7	1152	0x0480	R/W	Scale point 6 to 100.0% can only be set when Scale point 6 is not equal to 100.0%	100
Display point 7	1153	0x0481	R/W	Span of the input range	1000
Scale point 8	1154	0x0482	R/W	Scale point 7 to 100.0% can only be set when Scale point 7 is not equal to 100.0%	100
Display point 8	1155	0x0483	R/W	Span of the input range	1000
Scale point 9	1156	0x0484	R/W	Scale point 8 to 100.0% can only be set when Scale point 8 is not equal to 100.0%	100
Display point 9	1157	0x0485	R/W	Span of the input range	1000
Scale point 10	1158	0x0486	R/W	Scale point 9 to 100.0% can only be set when Scale point 9 is not equal to 100.0%	100
Display point 10	1159	0x0487	R/W	Span of the input range	1000
Scale point 11	1160	0x0488	R/W	Scale point 10 to 100.0% can only be set when Scale point 10 is not equal to 100.0%	100
Display point 11	1161	0x0489	R/W	Span of the input range	1000
Scale point 12	1162	0x048A	R/W	Scale point 11 to 100.0% can only be set when Scale point 11 is not equal to 100.0%	100
Display point 12	1163	0x048B	R/W	Span of the input range	1000

Scale point 13	1164	0x048C	R/W	Scale point 12 to 100.0% can only be set when Scale point 12 is not equal to 100.0%	100
Display point 13	1165	0x048D	R/W	Span of the input range	1000
Scale point 14	1166	0x048E	R/W	Scale point 13 to 100.0% can only be set when Scale point 13 is not equal to 100.0%	100
Display point 14	1167	0x048F	R/W	Span of the input range	1000
Scale point 15	1168	0x0490	R/W	Scale point 14 to 100.0% can only be set when Scale point 14 is not equal to 100.0%	100
Display point 15	1169	0x0491	R/W	Span of the input range	1000
Input failure Mode	1182	0x049E	R/W	0 = Fail High 1 = Fail Low	0
Input Peak Detection	1183	0x049F	R/W	0 = Disabled 1 = Maximum Peak 2 = Minimum Peak	0
Input 2 User Calibration (non Strain Gauge Types)					
Process Input User Calibration Type	1171	0x0493	R/W	0 = No User Calibration 1 = Single Point Calibration 2 = Two Point Calibration	0
Process Input Low Temperature Calibration Point	1172	0x0494	R/W		0
Process Input Low Calibration Offset	1173	0x0495	R/W		0
Process Input High Temperature Calibration Point	1174	0x0496	R/W		2192.5
Process Input High Calibration Offset	1175	0x0497	R/W		0
Input 2 Strain Gauge User Calibration					
Shunt Resistor	1176	0x0498	R/W	0 = Disabled 1 = Enabled	1
Calibration Resistor	1177	0x0499	R/W	40 – 100% of transducer full scale	80
Calibration start	1178	0x049A	R/W	Write 51966 (0xCAFE) to begin the selected calibration attempt	0

Calibration Status	1179	0x049B	R	Returns latest calibration status for Input2: 0 = None 1 = Busy 2 = Wait Lo 3 = Wait Hi 4 = Complete 5 = CNT Fail 6 = RCAL Fail	0
Calibration mode	1180	0x049C	R/W	Write 1 to Select Input 2 Low Calibration Write 2 to Select Input 2 High Calibration	NA
<p>Each calibration stage requires two Modbus writes. The first tells the unit which input you want to calibrate and if this is to be the Low or High calibration. The second is a password that tells the unit to execute the calibration attempt.</p> <p><u>To perform Strain Gauge Calibration on Input2</u></p> <ol style="list-style-type: none"> 1. Write "1" to register 1180 <i>Selects Low Calibration</i> 2. Write "51966" to register 1178 <i>Calibration is attempted</i> 3. Write "2" to register 1180 <i>Selects High Calibration</i> 4. Write "51966" to register 1178 <i>Calibration is attempted</i> <p>It is advisable to read the status between the low and high calibration stages to ensure low cal has completed successfully before performing the high cal</p>					

Digital inputs

Parameter Name	Modbus Address (Dec)	Modbus Address (Hex)	Access R/W	Notes		Default
Digital Input A Function Selection	7880	0x1EC8	R/W	Value	Function	0
				0	None	
				1	Input 1 Peak Reset	
				2	Input 2 Peak Reset	
				3	Input 1/2 Peak Reset	
				4	Alarm Reset	
				5	Input 1 Peak And Alarm Reset	
				6	Input 2 Peak And Alarm Reset	
				7	Input 1/2 Peak And Alarm Reset	
				8	Input 1 Zero Calibration	
				9	Input 2 Zero Calibration	
				10	Input 1/2 Zero Calibration	
				11	Input 1 Zero Cal, Alarm and Peak reset	
				12	Input 2 Zero Cal, Alarm and Peak reset	
				13	Input 1/2 Zero Cal, Alarm and Peak reset	
				14	Start Data Recorder	
				15	Setpoint Selection	
				16	Auto Manual Control	
				17	PID Control Outputs	
18	Run Pretune					
19	Run Selftune					

				20	Control Loop Input select	
				21	Up Key Selection mimic	
				22	Down Key Selection mimic	
				23	Back Key Selection mimic	
				24	Right Key Selection mimic	
				25	Increment Control Output	
				26	Decrement Control Output	
Digital Input 1 Function Selection	7881	0x1EC9	R/W	As Digital Input A		0
Digital Input 2 Function Selection	7882	0x1ECA	R/W	As Digital Input A		0
Digital Input 3 Function Selection	7883	0x1ECB	R/W	As Digital Input A		0
Digital Input 4 Function Selection	7884	0x1ECC	R/W	As Digital Input A		0

Option Slot 1 parameters

Parameter Name	Modbus Address (Dec)	Modbus Address (Hex)	Access R/W	Notes	Default
Output type	2130	0x0852	R/W	0 = No option fitted 1 = Relay255 = Illegal/Invalid	1
Digital Output state	2132	0x0854	R	0 = Inactive 1 = Active	
Output function selection	2146	0x0862	R/W	0 = Disabled 1 = Primary output power 2 = Secondary output power 3 = Alarm 1 Direct Acting 4 = Alarm 1 Reverse Acting 5 = Alarm 2 Direct Acting 6 = Alarm 2 Reverse Acting 7 = Alarm 3 Direct Acting 8 = Alarm 3 Reverse Acting 9 = Alarm 1 Or Alarm 2 Direct Acting 10 = Alarm 1 Or Alarm 2 Reverse Acting 11 = Alarm 1 Or Alarm 2 Or Alarm 3 Direct Acting 12 = Alarm 1 Or Alarm 2 Or Alarm 3 Reverse Acting	0
Output Latching	2135	0x0857	R/W	0 = Disabled 1 = Enabled	0
Output latch Reset	2136	0x0858	R/W	0 = Do Nothing 1 = Clear Latch	
Output Latch State	2137	0x0859	R	0 = Clear 1 = Latched	

Option Slot 2 parameters

Parameter Name	Modbus Address (Dec)	Modbus Address (Hex)	Access R/W	Notes	Default
Output type	2160	0x0870	R/W	0 = No option fitted 1 = Relay 9 = Duel Relay 255 = Illegal/Invalid	1
Output A state	2162	0x0872	R	0 = Inactive 1 = Active	
Output A function selection	2176	0x0880	R/W	0 = Disabled 1 = Primary output power 2 = Secondary output power 3 = Alarm 1 Direct Acting	0

				4 = Alarm 1 Reverse Acting 5 = Alarm 2 Direct Acting 6 = Alarm 2 Reverse Acting 7 = Alarm 3 Direct Acting 8 = Alarm 3 Reverse Acting 9 = Alarm 1 Or Alarm 2 Direct Acting 10 = Alarm 1 Or Alarm 2 Reverse Acting 11 = Alarm 1 Or Alarm 2 Or Alarm 3 Direct Acting 12 = Alarm 1 Or Alarm 2 Or Alarm 3 Reverse Acting	
Output A Latching	2165	0x0875	R/W	0 = Disabled 1 = Enabled	0
Output A latch Reset	2166	0x0876	R/W	0 = Do Nothing 1 = Clear Latch	
Output A Latch State	2167	0x0877	R	0 = Clear 1 = Latched	
Output B state	2163	0x0873	R	0 = Inactive 1 = Active	
Output B function selection	2177	0x0881	R/W	0 = Disabled 1 = Primary output power 2 = Secondary output power 3 = Alarm 1 Direct Acting 4 = Alarm 1 Reverse Acting 5 = Alarm 2 Direct Acting 6 = Alarm 2 Reverse Acting 7 = Alarm 3 Direct Acting 8 = Alarm 3 Reverse Acting 9 = Alarm 1 Or Alarm 2 Direct Acting 10 = Alarm 1 Or Alarm 2 Reverse Acting 11 = Alarm 1 Or Alarm 2 Or Alarm 3 Direct Acting 12 = Alarm 1 Or Alarm 2 Or Alarm 3 Reverse Acting	0
Output B Latching	2168	0x0878	R/W	0 = Disabled 1 = Enabled	0
Output B latch Reset	2169	0x0879	R/W	0 = Do Nothing 1 = Clear Latch	
Output B Latch State	2170	0x087A	R	0 = Clear 1 = Latched	

Option Slot 3 parameters

Parameter Name	Modbus Address (Dec)	Modbus Address (Hex)	Access R/W	Notes	Default
Output type	2192	0x0890	R/W	0 = No option fitted 1 = Relay 9 = Duel Relay 11 = TX PSU 255 = Illegal/Invalid	0

Output A state	2194	0x0892	R	0 = Inactive 1 = Active	
Output A function selection	2205	0x089D	R/W	0 = Disabled 1 = Primary output power 2 = Secondary output power 3 = Alarm 1 Direct Acting 4 = Alarm 1 Reverse Acting 5 = Alarm 2 Direct Acting 6 = Alarm 2 Reverse Acting 7 = Alarm 3 Direct Acting 8 = Alarm 3 Reverse Acting 9 = Alarm 1 Or Alarm 2 Direct Acting 10 = Alarm 1 Or Alarm 2 Reverse Acting 11 = Alarm 1 Or Alarm 2 Or Alarm 3 Direct Acting 12 = Alarm 1 Or Alarm 2 Or Alarm 3 Reverse Acting	0
Output A Latching	2197	0x0895	R/W	0 = Disabled 1 = Enabled	0
Output A latch Reset	2198	0x0896	R/W	0 = Do Nothing 1 = Clear Latch	
Output A Latch State	2199	0x0897	R	0 = Clear 1 = Latched	
Output B state	2195	0x0893	R	0 = Inactive 1 = Active	
Output B function selection	2206	0x089E	R/W	0 = Disabled 1 = Primary output power 2 = Secondary output power 3 = Alarm 1 Direct Acting 4 = Alarm 1 Reverse Acting 5 = Alarm 2 Direct Acting 6 = Alarm 2 Reverse Acting 7 = Alarm 3 Direct Acting 8 = Alarm 3 Reverse Acting 9 = Alarm 1 Or Alarm 2 Direct Acting 10 = Alarm 1 Or Alarm 2 Reverse Acting 11 = Alarm 1 Or Alarm 2 Or Alarm 3 Direct Acting 12 = Alarm 1 Or Alarm 2 Or Alarm 3 Reverse Acting	0
Output B Latching	2200	0x0898	R/W	0 = Disabled 1 = Enabled	0
Output B latch Reset	2201	0x0899	R/W	0 = Do Nothing 1 = Clear Latch	
Output B Latch State	2202	0x089A	R	0 = Clear 1 = Latched	

Linear Output A parameters

Parameter Name	Modbus Address (Dec)	Modbus Address (Hex)	Access R/W	Notes	Default	
Linear output range	3011	0x0BC3	R/W	Value	Range	1
				0	0 – 5V	
				1	0 – 10V	
				2	2 – 10V	
				3	0 – 20mA	
				4	4 – 20mA	
				5	0 – 10V DC Supply	
Linear Output Usage	2144	0x0860	R/W	Value	Usage	1
				0	None	
				1	Primary Control Power	
				2	Secondary Control Power	
				3	Retransmit SP	
				4	Retransmit Input 1PV	
				5	Retransmit Input 2PV	
6	Retransmit Differential					
0 – 10V DC Supply	3014	0x0BC6	R/W	0 to 10V as a percentage between 0 - 100	0	
Input 1 Retransmit Minimum	2152	0x0868	R/W		0	
Input 1 Retransmit Maximum	2153	0x0869	R/W		10000	
Input 2 Retransmit Minimum	2400	0x0960	R/W		0	
Input 2 Retransmit Maximum	2401	0x0961	R/W		10000	

10.9 Linear Output B parameters

Parameter Name	Modbus Address (Dec)	Modbus Address (Hex)	Access R/W	Notes	Default	
Linear output range	3021	0x0BCD	R/W	Value	Range	1
				0	0 – 5V	
				1	0 – 10V	
				2	2 – 10V	
				3	0 – 20mA	
				4	4 – 20mA	
				5	0 – 10V DC Supply	
Linear Output Usage	2174	0x087E	R/W	Value	Usage	1
				0	None	

				<table border="1"> <tr><td>1</td><td>Primary Control Power</td></tr> <tr><td>2</td><td>Secondary Control Power</td></tr> <tr><td>3</td><td>Retransmit SP</td></tr> <tr><td>4</td><td>Retransmit Input 1PV</td></tr> <tr><td>5</td><td>Retransmit Input 2PV</td></tr> <tr><td>6</td><td>Retransmit Differential</td></tr> </table>	1	Primary Control Power	2	Secondary Control Power	3	Retransmit SP	4	Retransmit Input 1PV	5	Retransmit Input 2PV	6	Retransmit Differential	
1	Primary Control Power																
2	Secondary Control Power																
3	Retransmit SP																
4	Retransmit Input 1PV																
5	Retransmit Input 2PV																
6	Retransmit Differential																
0 – 10V DC Supply	3024	0x0BD0	R/W	0 to 10V as a percentage between 0 - 100	0												
Input 1 Retransmit Minimum	2182	0x0886	R/W		0												
Input 1 Retransmit Maximum	2183	0x0887	R/W		10000												
Input 2 Retransmit Minimum	2430	0x097E	R/W		0												
Input 2 Retransmit Maximum	2431	0x097F	R/W		10000												

Setpoint parameters (ATC Only)

Parameter Name	Modbus Address (Dec)	Modbus Address (Hex)	Access R/W	Notes	Default
Setpoint Minimum	3944	0x0F68	R/W	Limited by input range maximum/minimum	0
Setpoint Maximum	3945	0x0F69	R/W	Limited by input range maximum/minimum	10000
Setpoint 1A Value	3960	0x0F78	R/W	Limited by Setpoint maximum/minimum	0
Setpoint 1A Offset	3961	0x0F79	R/W	Local offset	0
Setpoint 1B Value	3962	0x0F7A	R/W	Limited by Setpoint maximum/minimum	0
Setpoint BA Offset	3963	0x0F7B	R/W	Local offset	0
Setpoint Selection	4122	0x101A	R/W	0 = Local Setpoint 1 1 = Local Setpoint 2	0
Ramp rate in Operator Mode	4126	0x101E	R/W	0 = Disable 1 = Enable	0
Setpoint Ramp Rate	4123	0x101B	R/W		0

Control parameters (ATC Only)

Parameter Name	Modbus Address (Dec)	Modbus Address (Hex)	Access R/W	Notes	Default
Primary Cycle Time	4301	0x10CD	R/W	0.5 to 512.0	32
Secondary Cycle Time	4302	0x10CE	R/W	0.5 to 512.0	32
Auto/Manual Control	4308	0x10D4	R/W	0 = Automatic 1 = Manual	1
Control Enable/Disable	4309	0x10D5	R/W	0 = Enable 1 = Disable	0
Control Type	4310	0x10D6	R/W	0 = Single (Heat Only) 1 = Dual (Heat/Cool) 2 = Pressure	2
Control Action	4311	0x10D7	R/W	0 = Reverse 1 = Direct	0
Proportional Band 1	4312	0x10D8	R/W	0.0 to 9999.9	100
Secondary (Cool) Proportional Band	4313	0x10D9	R/W	0.0 to 9999.9 (Only available on Heat Cool Variant)	100
Integral/Reset	4314	0x10DA	R/W	0.0 to 6000.0	5
Derivative/Rate	4315	0x10DB	R/W	0.0 to 5999	0
Bias	4316	0x10DC	R/W	For single control 0 to 100, for Dual control -100 to 100	25
Overlap/DeadBand	4317	0x10DD	R/W	+/-20% of the proportional band (As a percentage) (Only available on Heat Cool Variant)	0
Primary On/Off Diff	4318	0x10DE	R/W	0.1 to 10.0	0.5
Secondary On/Off Diff	4319	0x1DDF	R/W	0.1 to 10.0	0.5
On/Off Differential	4320	0x10E0	R/W	0.0 to 300.0	27
Heat/Primary Power Upper limit	4321	0x10E1	R/W	10 to 100% Cannot be made smaller than Heat/Primary Lower limit + 10	100
Heat/Primary Power Lower limit	4322	0x10E2	R/W	0 to 90% Cannot be made larger than Heat/Primary Upper limit – 10	0
Cool/Secondary Power Upper limit	4323	0x10E3	R/W	10 to 100% Cannot be made smaller than Cool/Secondary Lower limit + 10	100
Cool/Secondary Power Lower limit	4324	0x10E4	R/W	0 to 90% Cannot be made larger than Cool/Secondary Upper limit – 10	0
Pretune Enable	4325	0x10E5	R/W	0 = Disabled 1 = Enabled	0

Self tune Enable	4326	0x10E6	R/W	0 = Disabled 1 = Enabled	0
------------------	------	--------	-----	-----------------------------	---

Loop Alarm Type	4327	0x10E7	R/W	0 = Off 1 = Time 2 = Auto	2
Loop Alarm time	4328	0x10E8	R/W	1 to 5999	1
Primary Power	4329	0x10E9	R	0 to 100%	
Secondary Power	4330	0x10EA	R	0 to 100%	
Combined Power	4331	0x10EB	R/W	-100 to 100%	
Pretune Status	4332	0x10EC	R	0 = Inactive 1 = Active	
Self tune Status	4333	0x10ED	R	0 = Inactive 1 = Active	
Loop Alarm status	4334	0x10EE	R	0 = Inactive 1 = Active	
Preset Power	4335	0x10EF	R/W	-100% to 100%	0
Auto Pre-tune	4336	0x10F0	R/W	0 = Disabled 1 = Enabled	0
Scaled Power	4345	0x10F9	R/W	0 = Disabled 1 = Enabled	0
Scaled RPM Value for 0 % Power	4346	0x10FA	R/W		0
Scaled RPM Value for 100 % Power	4347	0x10FB	R/W		100
Scaled Power Value	4348	0x10FC	R		
Startup Control	4349	0x10FD	R/W	0 = Automatic 1 = Manual	1
Tuning Settings					
Auto/Manual Transfer	4128	0x1020	R/W	0 = Bumpless Mode 1 = Setpoint Mode	0
Output Pulse	4350	0x10FE	R/W	-25 to 25	10
Standby Threshold	4355	0x1103	R/W	0 to 1500	0
Standby Recovery Time	4356	0x1104	R/W	0 to 60	30
Standby Active Limit	4358	0x1106	R/W	0 to 100	20

Alarm parameters

Alarm 1

Parameter Name	Modbus Address (Dec)	Modbus Address (Hex)	Access R/W	Notes	Default
Alarm Type	6143	0x17FF	R/W	0 = Unused 1 = High Alarm 2 = Low Alarm 3 = Deviation Alarm 4 = Band Alarm 5 = Input Rate of change 6 = Sensor Break Alarm 7 = Control Loop 10 = % Memory Used 11 = High Power 12 = Low Power	0
Alarm Input Source	6144	0x1800	R/W	0 = Universal Input 1 1 = Universal Input 2 2 = Differential 3 = Aux A Input 4 = Control Pri Power 5 = Control Sec Power	0
Alarm Value	6145	0x1801	R/W	Limited by the input range maximum and minimum for Alarm types 0 and 1. Limited by the span of the input range for alarm types 2 and 3. Not used for alarms 4 and 5.	0
Alarm Hysteresis	6146	0x1802	R/W	Limited by the span of the input range	10
Alarm inhibit	6147	0x1803	R/W	0 = Disabled 1 = Enabled	0
Alarm status	6148	0x1804	R	0 = Inactive 1 = Active 2 = Unused	
Alarm inhibit status	6149	0x1805	R	0 = Not inhibited 1 = Inhibited	
Rate Minimum Time Alarm Value	6150	0x1806	R/W	1.0 to 9999.0	1
Alarm Label	6151	0x1807	R/W	Label for the Alarm (Max 16 chars)	Alarm 1
Alternate Language Alarm Label	6152	0x1808	R/W	Label for the Alarm alternate language (Max 16 chars)	
Alarm Filter Time	6153	0x1809	R/W	Time in seconds 0.5 to 100.0	0.5
Alarm Failure Mode	6154	0x180A	R/W	0 = Normal Mode 1 = Input Fail Mode	0

Parameter Name	Modbus Address (Dec)	Modbus Address (Hex)	Access R/W	Notes	Default
Alarm Type	6159	0x180F	R/W	0 = Unused 1 = High Alarm 2 = Low Alarm 3 = Deviation Alarm 4 = Band Alarm 5 = Input Rate of change 6 = Sensor Break Alarm 7 = Control Loop 10 = % Memory Used 11 = High Power 12 = Low Power	0
Alarm Input Source	6160	0x1810	R/W	0 = Universal Input 1 1 = Universal Input 2	0
Alarm Value	6161	0x1811	R/W	Limited by the input range maximum and minimum for Alarm types 0 and 1. Limited by the span of the input range for alarm types 2 and 3. Not used for alarms 4 and 5.	0
Alarm Hysteresis	6162	0x1812	R/W	Limited by the span of the input range	10
Alarm inhibit	6163	0x1813	R/W	0 = Disabled 1 = Enabled	0
Alarm status	6164	0x1814	R	0 = Inactive 1 = Active	
Alarm inhibit status	6165	0x1815	R	0 = Not inhibited 1 = Inhibited	
Rate Minimum Time Alarm Value	6166	0x1816	R/W		1
Alarm Label	6167	0x1817	R/W	Label for the Alarm	Alarm 2
Alternate Language Alarm Label	6152	0x1808	R/W	Label for the Alarm alternate language (Max 16 chars)	
Alarm Filter Time	6169	0x1819	R/W	Time in seconds 0.5 to 100.0	0.5
Alarm Failure Mode	6154	0x180A	R/W	0 = Normal Mode 1 = Input Fail Mode	0

Parameter Name	Modbus Address (Dec)	Modbus Address (Hex)	Access R/W	Notes	Default
Alarm Type	6175	0x181F	R/W	0 = Unused 1 = High Alarm 2 = Low Alarm 3 = Deviation Alarm 4 = Band Alarm 5 = Input Rate of change 6 = Sensor Break Alarm 7 = Control Loop 10 = % Memory Used 11 = High Power 12 = Low Power	0
Alarm Input Source	6176	0x1820	R/W	0 = Universal Input 1 1 = Universal Input 2	0
Alarm Value	6177	0x1821	R/W	Limited by the input range maximum and minimum for Alarm types 0 and 1. Limited by the span of the input range for alarm types 2 and 3. Not used for alarms 4 and 5.	0
Alarm Hysteresis	6178	0x1822	R/W	Limited by the span of the input range	10
Alarm inhibit	6179	0x1823	R/W	0 = Disabled 1 = Enabled	0
Alarm status	6180	0x1824	R	0 = Inactive 1 = Active	
Alarm inhibit status	6181	0x1825	R	0 = Not inhibited 1 = Inhibited	
Rate Minimum Time Alarm Value	6182	0x1826	R/W		1
Alarm Label	6183	0x1827	R/W	Label for the Alarm	Alarm 3
Alternate Language Alarm Label	6152	0x1808	R/W	Label for the Alarm alternate language (Max 16 chars)	
Alarm Filter Time	6185	0x1829	R/W	Time in seconds 0.5 to 100.0	0.5
Alarm Failure Mode	6154	0x180A	R/W	0 = Normal Mode 1 = Input Fail Mode	0

Logger parameters (Data Logger)

Data Recorder

Parameter Name	Modbus Address (Dec)	Modbus Address (Hex)	Access R/W	Notes	Default
Log Interval	7550	0x1D7E	R/W	0 = Every second 1 = Every 2 seconds 2 = Every 5 seconds 3 = Every 10 seconds 4 = Every 15 seconds 5 = Every 30 seconds 6 = Every Minute 7 = Every 2 Minutes 8 = Every 5 Minutes 9 = Every 10 Minutes 10 = Every 15 Minutes 11 = Every 30 Minutes	3
Log Mode	7551	0x1D7F	R/W	0 = Record until memory used 1 = Continues FIFO	0
Start/Stop Recorder	7552	0x1D80	R/W	0 = Stop 1 = Start	0
Recorder Fitted	7553	0x1D81	R	0 = Not Fitted 1 = Fitted	1
Memory Remaining	7554	0x1D82	R	In Bytes	
Time Remaining	7555	0x1D83	R	In seconds	
Recorder Trigger	7563	0x1D8B	R/W	0 = Operator Start Stop 1 = Recorder Menu Start/Stop 2 = From Alarm 3 = Digital Input 4 = Record while profile running	1
Trigger on Alarm 1	7584	0x1DA0	R/W	0 = Off 1 = Trigger	0
Trigger on Alarm 2	7585	0x1DA1	R/W	0 = Off 1 = Trigger	0
Trigger on Alarm 3	7586	0x1DA2	R/W	0 = Off 1 = Trigger	0
Force Record Abort	7589	0x1DA5	R/W	0 = Nothing – Does not abort 1 = Abort	
Recorder Status	7591	0x1DA7	R	0 = Not Recording 1 = Recording	
Record Input 1 PV	7572	0x1D94	R/W	0 = Off 1 = Record	0
Record Input 1 PV Max	7573	0x1D95	R/W	0 = Off 1 = Record	0
Record Input	7574	0x1D96	R/W	0 = Off	0

1 PV Min				1 = Record	
Record Input 2 PV	7607	0x1DB7	R/W	0 = Off 1 = Record	0
Record Input 2 PV Max	7608	0x1DB8	R/W	0 = Off 1 = Record	0
Record Input 2 PV Min	7609	0x1DB9	R/W	0 = Off 1 = Record	0
Record Local Setpoint	7575	0x1D97	R/W	0 = Off 1 = Record	0
Record Primary Power	7576	0x1D98	R/W	0 = Off 1 = Record	0
Record Secondary Power	7577	0x1D99	R/W	0 = Off 1 = Record	0
Record Alarm 1 Status	7578	0x1D9A	R/W	0 = Off 1 = Record	0
Record Alarm 2 Status	7579	0x1D9B	R/W	0 = Off 1 = Record	0
Record Alarm 3 Status	7580	0x1D9C	R/W	0 = Off 1 = Record	0
Record Power On/Off	7583	0x1D9F	R/W	0 = Off 1 = Record	0

Real time clock

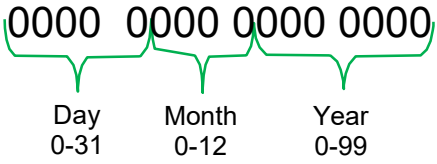
Parameter Name	Modbus Address (Dec)	Modbus Address (Hex)	Access R/W	Notes	Default
Date format	7868	0x1EBC	R	0 = dd/mm/yyyy (European Default) 1 = mm/dd/yyyy (USA Default)	0
Time	7869	0x1EBD	R/W	In seconds from midnight	
Date	7870	0x1EBE	R/W	<p>Binary coded decimal (BCD) 16 bits that represent the date as follows:</p> <div style="text-align: center;">  <p>0000 0000 0000 0000</p> <p>Day Month Year 0-31 0-12 0-99</p> </div> <p>So an example of setting the date to 31/07/2012</p> <p>Day = 31 = 11111 Month = 7 = 0111 Year = 12 = 0001100</p> <p>This would give the total BCD of: 11111 0111 0001100 or 64396.</p> <p>However reading this back out afterwards would return 195468 as the calculated day of</p>	
Day of the week	7872	0x1EC0	R	1 = Monday 2 = Tuesday 3 = Wednesday 4 = Thursday 5 = Friday 6 = Saturday 7 = Sunday	
RTC Fitted	7871	0x1EBF	R	0 = Not Fitted 1 = Fitted	

Display parameters

Keys

Parameter Name	Modbus Address (Dec)	Modbus Address (Hex)	Access R/W	Notes	Default
Key State	7669	0x1DF5	R	Current state of the keys	

LEDs

Parameter Name	Modbus Address (Dec)	Modbus Address (Hex)	Access R/W	Notes	Default
LED 1 Label	7656	0x1DE8	R/W	Max 6 charaters	STBY
LED 2 Label	7657	0x1DE9	R/W	Max 6 charaters	ALM1
LED 3 Label	7658	0x1DEA	R/W	Max 6 charaters	ALM2
LED 4 Label	7659	0x1DEB	R/W	Max 6 charaters	TUNE
LED 1 Alternate Language Label	7660	0x1DEC	R/W	Max 6 charaters	
LED 2 Alternate Language Label	7661	0x1DED	R/W	Max 6 charaters	
LED 3 Alternate Language Label	7662	0x1DEE	R/W	Max 6 charaters	
LED 4 Alternate Language Label	7663	0x1DEF	R/W	Max 6 charaters	
Backlight Colour	7668	0x1DF4	R/W	0 = Green to Red on Alarm 1 = Red to Green on Alarm 2 = Green 3 = Red	0

HMI

Parameter Name	Modbus Address (Dec)	Modbus Address (Hex)	Access R/W	Notes	Default
Language	7675	0x1DFB	R/W	0 = Downloaded Language 1 = English	0
LCD Contrast	7676	0x1DFC	R/W	0 to 100	50
Invert LCD	7677	0x1DFD	R/W	0 = Normal 1 = Inverted	0
Setup Lock Code	7678	0x1DFE	R/W	Default 10	10
Configuration Lock Code	7679	0x1DFF	R/W	Default 10	10
Tune Lock Code	7680	0x1E00	R/W	Default 10	10
Supervisor Lock Code	7681	0x1E01	R/W	Default 10	10
USB Lock Code	7683	0x1E03	R/W	Default 10	10
Recorder Lock Code	7684	0x1E04	R/W	Default 10	10
Input 1 Trend View Mode	9001	0x2329	R/W	0 = None 1 = PV 2 = PV and Setpoint 3 = PV Max/Min	2
Input 1 Trend View Interval	9000	0x2328	R/W	0 = Every second 1 = Every 2 seconds 2 = Every 5 seconds 3 = Every 10 seconds 4 = Every 15 seconds 5 = Every 30 seconds 6 = Every Minute 7 = Every 2 Minutes 8 = Every 5 Minutes 9 = Every 10 Minutes 10 = Every 15 Minutes 11 = Every 30 Minutes	0
Input 2 Trend View Mode	9011	0x2334	R/W	0 = None 1 = PV 3 = PV Max/Min	2
Input 2 Trend View Interval	9010	0x2332	R/W	0 = Every second 1 = Every 2 seconds 2 = Every 5 seconds 3 = Every 10 seconds 4 = Every 15 seconds 5 = Every 30 seconds 6 = Every Minute 7 = Every 2 Minutes 8 = Every 5 Minutes 9 = Every 10 Minutes 10 = Every 15 Minutes 11 = Every 30 Minutes	0

Contact Details

Parameter Name	Modbus Address (Dec)	Modbus Address (Hex)	Access R/W	Notes	Default
Contact Details line 1	400	0x0190	R/W	26 characters of text	Dynisco LLC
Contact Details line 2	401	0x0191	R/W	26 characters of text	38 Forge Parkway
Contact Details line 3	402	0x0192	R/W	26 characters of text	Franklin, MA, 02038
Contact Details line 4	403	0x0193	R/W	26 characters of text	USA
Contact Details line 5	404	0x0194	R/W	26 characters of text	Tel: +1 508 541 9400
Contact Details line 6	405	0x0195	R/W	26 characters of text	Fax: +1 508 541 6206
Contact Details line 7	406	0x0196	R/W	26 characters of text	

11 Calibration

WARNING:

CALIBRATION IS ONLY REQUIRED FOR INSTRUMENTS IN WHICH CALIBRATION ERRORS HAVE BEEN ENCOUNTERED. REFER TO CALIBRATION CHECK BELOW.

CAUTION:

Calibration must be performed by personnel who are technically competent and authorised to do so.

Calibration Reminder

Calibration of each input type is carried out during manufacture. This can be verified from Product Information Mode. Recorder versions can provide the user with a calibration reminder if the application requires regular checks – see Input Configuration for details. For most applications, re-calibration is not required during the lifetime of the instrument.

Equipment Required For Checking or Calibrating The Universal Input

A suitable calibration signal source is required for each input type. To verify the accuracy of the instrument or carry out recalibration, the listed input sources are required. These must have better than $\pm 0.05\%$ of the reading accuracy:

1. DC linear inputs: 0 to 50mV, 0 to 10VDC and 0 to 20mADC.
2. Thermocouple inputs - complete with 0°C reference facility, appropriate thermocouple functions and compensating leads (or equivalent).
3. RTD inputs: decade resistance box with connections for three-wire input (or equivalent).

Calibration Check

1. Set the instrument to the required input type.
 2. Power up the instrument and connect the correct input leads.
Leave powered up for at least five minutes for RTD and DC linear inputs, and at least 30 minutes for thermocouple inputs.
 3. After the appropriate delay for stabilisation, check the calibration by connecting the appropriate input source and checking a number of cardinal points.
The observed readings should be within the tolerances stated in the Specification (see Appendix 2)
 4. Repeat the test for all required input types.
-

Recalibration Procedure











Recalibration is carried out in five phases as shown in the table below; each phase corresponds to a basic input type.

CAUTION:

The 50mV phase MUST be calibrated before the thermocouple range.

Table 23. Input Calibration phases

DC milli-volt Calibration	50 mV
DC voltage Calibration	10 V
DC milliamps Calibration	20 mA
RTD Calibration	200 ohm
Thermocouple Calibration	K type source at 0°C

1. For optimum accuracy, power-up the instrument for 30 minutes, then toggle the power off/on to restart the instrument.
2. During the power-up “splash screen”, press  and  together until the Calibration Status screen is displayed.   
3. Press  to select the first calibration phase (50mV Calibration)
4. Ensure that an accurate 50mV signal has been applied to terminals 2 (+ve) and 3 (-ve), then press  +  to initiate the calibration.
5. During calibration the message “50mV DC Input Calibrating” will display for a few seconds. This should be followed by the “Calibration Successful” confirmation.
6. If the input is misconnected or an incorrect signal is applied, the calibration will be aborted and the display will show “Failed: Signal Too Small!” or “Failed: Signal Too Large!”. The previous calibration value will be retained.
7. Press  to select the next calibration phase.
8. Repeat this process for each input type until all the phases are calibrated. For each phase, ensure that the correct input is applied, using the correct connections.
9. Once all calibration phases are completed, recorder versions will display the Calibration Reminder Date. If required, this can be changed to the date of your next calibration check. Ensure that Calibration Reminders are enabled in Input Configuration to receive a reminder.
10. Press  +  to exit to the main menu.

Note:

Calibration Mode automatically exits if there is no button activity for two minutes.

12 Appendix 1 – Glossary of Terms Used

Active Set point

The term Active Set point is used to describe the currently selected set point when the instrument is in Controller Mode. Controllers can use Local Set point 1 and/or the Alternative Set point. Only one of the set points can be active at any time.

Also refer to: Actual Set point, Alternative Set point, Controller Mode, Local Set points, Remote Set point, Set point, and Set point Selection.

Actual Set point

Actual Set point is the effective current value of the active set point. This will be different to the Set point's target value if the set point is ramping. The actual set point will rise or fall at the ramp-rate set, until it reaches its target set point value. During Profiler Control, the Actual Set point value is controlled by the profiler function.

Also refer to: Active Set point, Controller Mode, Profiler Mode, Set point, Set point Ramp Rate and Set point Selection.

Alarm Configuration

A sub-menu of Configuration Mode used to adjust the alarm parameters. (Alarm types, values, hysteresis and inhibiting).

Also refer to: Alarm Hysteresis, Alarm Inhibit, Alarm Operation, Alarm Types and Configuration Mode.

Alarm Hysteresis

An adjustable band through which the process variable must pass before the alarm will change state. This Hysteresis is only applicable to alarms based on the Process Value or Control Deviation, as illustrated below. The band is always on the "safe" side of an alarm point, e.g. a high alarm's hysteresis band is below the high alarm value, and a low alarm's hysteresis is above the low alarm value. Rate Of Change Alarms have a different type of hysteresis based on the length of time the rate is above the threshold.

Settings = 1 LSD to full span from the set point.

Default value = 1 LSD.

Refer to the *Alarm Hysteresis Operation* diagram on the next page.

Also refer to: Alarm Types, Loop Alarm, Alarm Operation, LSD, Minimum Duration Of Change, Process Variable, and Rate Of Change Alarm.

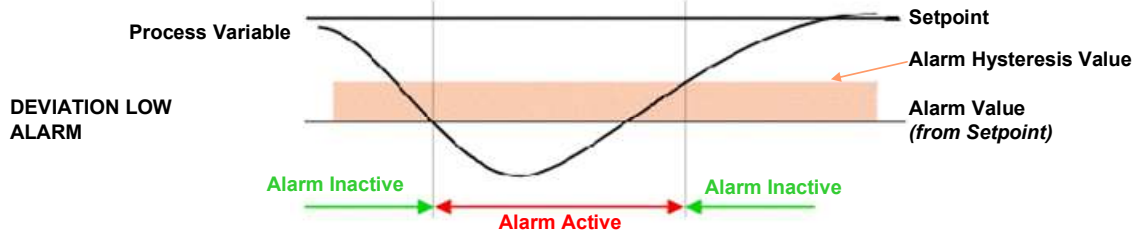
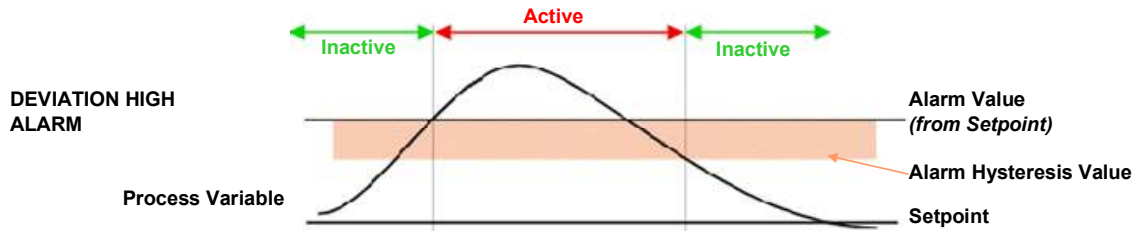
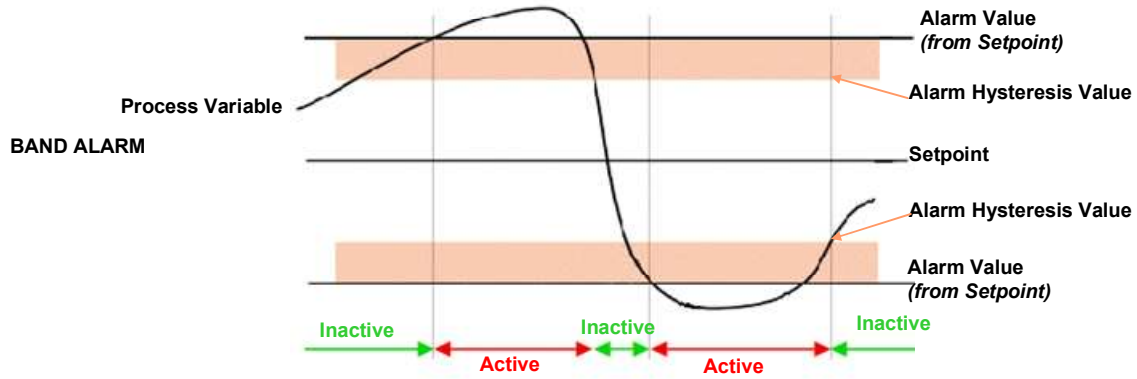
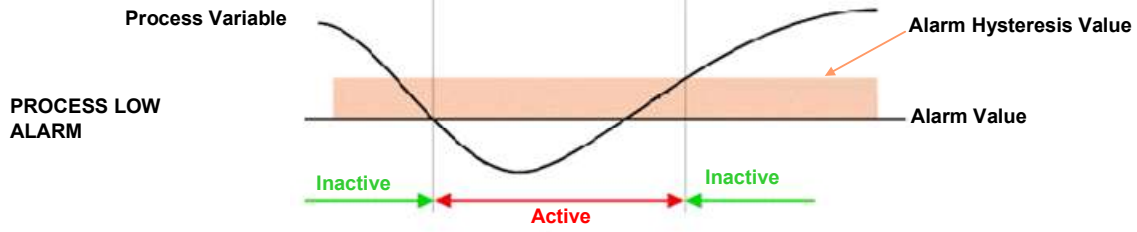
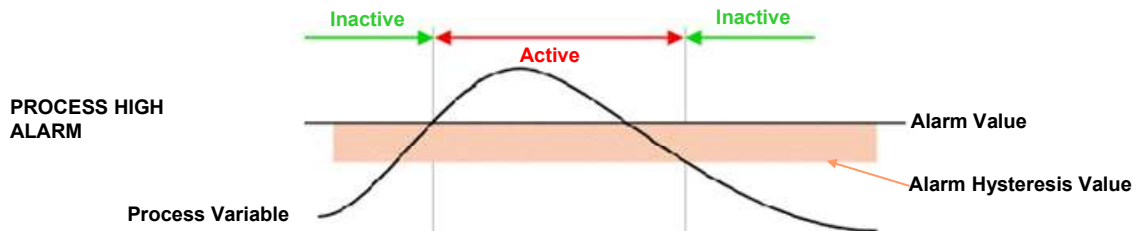

Alarm Operation

The Process and Deviation Alarm types are illustrated, together with the action of any associated outputs.

Also refer to: *Alarm Hysteresis, Alarm Inhibit, Alarm Types, Band Alarm Value, Deviation Alarm, Latching Relay, Logical Alarm Combinations, Loop Alarm, Process High Alarm and Process Low Alarm.*

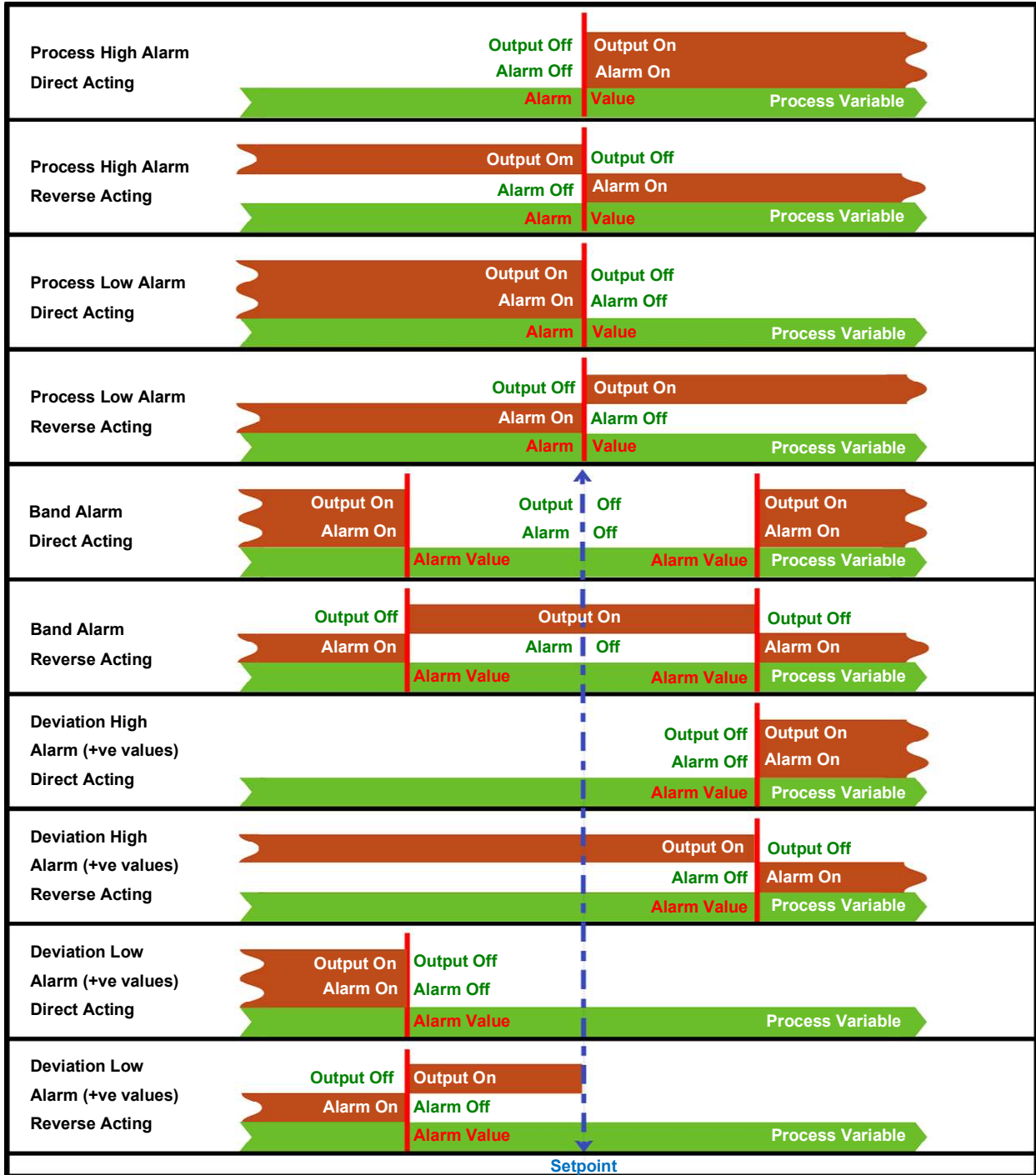

Figure 24. Alarm Operation

Alarm Inhibit

Alarm Inhibit prevents unwanted process or deviation alarm activation at power-up or when the controller set point is changed. The alarm activation is inhibited until a 'Safe' condition is present. The alarm operates normally from that point onwards. E.g. if inhibited, a low alarm will not activate at power-up, until the process has first risen above the alarm point and then falls back below.

Settings = Inhibit or not inhibited for each alarm.

Default value = None Inhibited.

Also refer to: Alarm Types and Alarm Operation.

Alarm Types

There are four basic alarm types, Process Alarms, Control Deviation Alarms, Rate of Signal Change Alarms and Event Based Alarms.

Process Alarms are based on the absolute value of the Process Variable. If the PV rises above a high alarm value, or falls below a low alarm value, the alarm will become active.

Deviation Alarms are based on the value of the Control Deviation error. If the PV is more than the high deviation alarm value above set point, or more than the low deviation alarm value below set point, the alarm will become active.

Rate Of Signal Change Alarms are based on the rate of change of the PV. If the rate of change is greater than the alarm value for longer than the Minimum Duration time, the alarm will activate.

Event based alarms activate when the condition for that alarm type is true. These can be Signal Break, Low Memory Or Loop Alarms.

Also refer to: Alarm Operation, Band Alarm Value, Control Deviation, Deviation Alarm, Loop Alarm, Process High Alarm, Process Low Alarm, Process Variable, Rate Of Change Alarm, and Set point.

Alternative Set point

The instrument can have up to two set points. Local Set point 1 or a remote set point input from the Auxiliary Input if fitted. One set point can be chosen as the active at using the Set point Selection.

Also refer to: Auxiliary Input, Local Set points, Remote Set points; Set point and Set point Select.

Auto Pre-Tune

When the Auto Pre-Tune is enabled, a Pre-Tune activation is attempted at every power-up (*standard Pre-Tune activation rules apply*). Auto Pre-Tune is useful when the process to be controlled may vary significantly each time it is run. Auto Pre-Tune ensures that the process is tuned correctly each time the process is started. Self-Tune may also be engaged to fine-tune the controller.

Settings = Enabled or Disabled.

Default value = Disabled.

Also refer to: Pre-Tune, Self-Tune, PI and Tuning.

Automatic Reset

- Refer to *Integral Action*

variable settles below set point use a higher Bias value to remove the error, if the process variable settles above the set point use a lower Bias value. Integral action performs a similar function automatically when using PI or PI control.

Lower Bias values will also help to reduce overshoot at process start up.

Settings = 0 to 100% (-100% to +100% for dual control).

Default value = 25%.

Also refer to: Control Deviation, Integral Action, ON/OFF Control, PI Control, PI, Proportional Control, Process Variable, and Set point.

Bumpless Transfer

A method used to prevent sudden changes to the correcting variable, when switching between automatic PI or PI and Manual control modes. During a transition from PI or PI to Manual control, the initial Manual Power value is set to the previous automatic mode value. The operator then adjusts the value as required. During a transition from Manual control to PI or PI, the initial automatic value is set to the previous Manual mode value. The correcting variable level will gradually adjusted by the control algorithm at a rate dependant on the integral action resulting from the Integral Time Constant value. Since integral action is essential to Bumpless Transfer, this feature is not available if Integral is turned off.

Also refer to: Correcting Variable, Integral Action, Manual Mode, PI and PI.

Cascade Control

Applications with two or more capacities (such as heated jackets) are inherently difficult for a single instrument to control, due to large overshoots and unacceptable lags. The solution is to cascade two or more controllers, each with its own input, in series to form a single regulating device. The product set point temperature is set on the master controller. This is compared to the product temperature, and the master's PI output (mA or VDC) is fed into the auxiliary input of the slave controller as a remote set point input. The RSP is scaled to suit any expected temperature. The slave loop's natural response time should ideally be at least 5 times faster than the master.

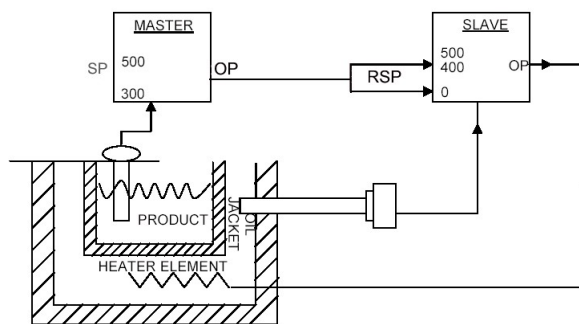

In the example, the maximum input represents 400°C, thus restricting the jacket temperature. At start-up the master compares the product temperature (ambient) to its set point (300°C) and gives maximum output. This sets the maximum (400°C) set point on the slave, which is compared to the jacket temperature (ambient) giving maximum heater output.

As the jacket temperature rises, the slave's heater output falls. The product temperature also rises at a rate dependant on the transfer lag between the jacket and product. This causes the master's PI output to decrease, reducing the 'jacket' set point on the slave, effectively reducing the output to the heater. This continues until the system becomes balanced.

When tuning a cascade system, first set the master to manual mode. Tune the slave controller using proportional control only (I & D are not normally required) then return the master to automatic PI mode before tuning the master. The result is quicker, smoother control with minimum overshoot and the ability to cope with load changes, whilst keeping the jacket temperature within acceptable tolerances.

Also refer to: Auxiliary Input, Auxiliary Input Lower Limit, Auxiliary Input Upper Limit, Derivative Action, Integral Action, mADC, Manual Mode, Master & Slave, Proportional

Control, PI, Remote Set point, Auxiliary Input Lower Limit, Auxiliary Input Upper Limit, Set point, Set point Select, Tuning and VDC.

Clock Configuration

A sub-menu of Configuration Mode used to adjust the parameters that relate to the settings for the Real Time Clock fitted with the data recorder option (Date, time, and day of week and date format).

Also refer to: Data Recorder and Configuration Mode

Communications Write Enable

Enables/disables the changing of parameter values via the Serial Communications link, if a communication option such as Modbus RTU (RS485) or Modbus TCP (Ethernet) is installed. When disabled, all communications are read-only.

Settings = Read Only or Read/Write.

Default setting = Enabled (read/write).

Also refer to: Ethernet, Modbus RTU, Modbus TCP, RS485 and Serial Communications

Configuration Menu

A selection of sub-menus from which the user can adjust the major instrument settings. There are sub-menus for the Inputs, Control, Outputs, Alarms, Communications, Recorder, Clock, Display and Lock Codes. Configuration Mode is entered from the Main Menu. An unlock code is required to access this mode.

Refer to the Configuration Menu information in the Configuration & Use section.

Also refer to: Alarm Configuration, Lock Codes, Clock Configuration, Control Configuration, Display Configuration, Input Configuration, Main Menu, Output Configuration, Recorder Configuration, Serial Communications Configuration

Contactors

- Refer to *Relay*

Control Configuration

A sub-menu of Configuration Mode used to adjust the parameters that relate to the control of the process. (Enabling control, auto/manual mode, control type and action, PI tuning terms, power limits, sensor break action, local set point values, set point ramp rates and set point selection).

Also refer to: Configuration Mode, Control Action, Control Enable, Local Set points, Manual Mode, PI, Power Limits, Sensor Break Pre-Set Power, Set point Ramping, Set point Selection and Tuning

Control Deviation

Control Deviation is the difference between the Process Variable value and the Set point. The Control deviation error is equal to $PV - SP$. This value can be monitored using the bar-graph, and an excessive deviation warning can be given by using a deviation alarm.

Also refer to: Actual Set point, Alarm Types, Bar Graph, Deviation Alarm, Process Variable and Set point

Control Action

The primary power output direction. Reverse action is typically used with heating applications as it increases the correcting variable as the process variable falls. A secondary output's

action is always the opposite of the primary output.

Settings = Reverse or Direct

Default value = Reverse.

Also refer to: Control Type, Correcting Variable, Direct Acting Control and Reverse Acting Control.

Control Enable/Disable

The PI controller outputs can be temporarily turned off by disabling the control. All other functions continue as normal. The control enable/disable function can be controlled from the Control Configuration sub-menu or optionally from Operation Mode or via a digital input if one is fitted.

Also refer to: Configuration Menu, Digital Input, and Operation Mode

Control Type

This defines if a controller has Single (unidirectional) or Dual (bidirectional) control outputs. Single outputs have a Primary output only. This can drive the PV in one direction (e.g. heat only, cool only, increase humidity etc). Dual outputs have both Primary and Secondary outputs which can force the PV to increase or decrease (e.g. heat & cool, humidify and dehumidify etc).

Settings = Single or Dual

Default value = Single.

Also refer to: Control Action, PI, Primary Proportional Band, Process Variable, and Secondary Proportional Band.

Controller

An instrument that controls a process variable to a target set point, by applying a correcting variable. The controller uses proportional (P, PI, or On-Off control methods.

Also refer to: Correcting Variable, Indicator, Limit Controller, On-Off Control, PD Control, PI Control, PI, Process Variable, Proportional Control, Profiler and Set point.

Correcting Variable

The amount of output from a controller used to adjust the process variable value up or down, to remove any control deviation. The correcting variable is commonly referred to as the controller output power.

Also refer to: Control Deviation, PI, Primary Power Output Limit and Process Variable

CPU

This stands for Central Processing Unit and refers to the onboard microprocessor that controls the measurement, control, alarm and display functions of the instrument.

Current Proportioning Control

Current proportioning control is used to produce the correcting variable on units with linear output(s). It provides 4 to 20mA, 0-20mA, 0 to 5V, 0 to 10V or 2 - 10V DC for proportional control, PI, PD or PI control modes. On-Off control cannot be used with linear outputs.

Also refer to: Correcting Variable, Linear Output, On-Off Control, PD, PI, PI, Proportional Control, and Time Proportional Control.

Custom Display Mode

The user can copy up to 50 Configuration Menu parameters into Operation Mode using the PC software. If the Custom Display is enabled in the Display Configuration sub-menu, these

screens follow the normal Operation Mode screens. In this mode these screens are not pass-code protected.

Also refer to: Control Configuration, Display Configuration and Operation Mode

Cycle Time

For time proportioning outputs, the cycle time is used to define the time over which the controller averages the ON vs. OFF time, in order to provide the required correcting variable. Each Time-Proportioning output has its own adjustable cycle time. Shorter cycle times give better control, but at the expense of reduce life when used with electromechanical control devices (e.g. relays or solenoid valves). There are separate cycle times for the Primary and Secondary control outputs

Settings = 0.5 to 512 seconds

Default value = 32 secs.

Also refer to: Correcting Variable, PI, Primary Proportional Band, Proportional Control, Relay, Secondary Proportional Band, Solenoid Valve and Time Proportioning.

Data Recorder

The Data Recorder option can record the process value, set point, alarms and events over time. Recordings can be transferred to a USB memory stick or via the serial communications options. This option includes a USB Interface and a battery backed-up Real Time Clock.

Refer to the Data Recorder Option section of this manual for more details.

Also refer to: Recorder Configuration.

Dead band

- Refer to *Overlap/Dead band*.

Derivative Action

The Derivative Time Constant defines how the control action responds to the rate of change in the process variable. The power is decreased if the PV is rising, or increased if the PV is falling. This parameter is not available if primary control output is set to On-Off, and it is normally set to OFF in modulating value applications as it can cause premature wear due to constant small adjustments to the valve position.

Settings = OFF or 0 seconds to 99 minutes 59 seconds

Default value = 01.15.

Also refer to: Modulating Valve, On-Off Control, PD Control, PI Control, PI, Process Variable, Tuning and Valve Motor Drive Control.

Deviation Alarm Value

Defines the amount of control deviation considered acceptable before a deviation alarm is activated. A positive value (deviation high) sets the alarm point above the current actual set point; a negative value (deviation low) sets the alarm point below actual set point. If the process variable deviates from the actual set point by a margin greater than this value, the deviation alarm becomes active. If an alarm is required if the control deviation is either side of the set point, consider using a Band alarm or a logical combination of a deviation high and deviation low alarm.

Settings = 1 LSD to full span from the set point

Default value = 5 LSD's.

Also refer to: Actual Set point, Alarm Operation, Alarm Types, Band Alarm, Control Deviation, Logical Combination, Process Variable and Set point.

Digital Input

An input that can be driven to one of two states (active or inactive) by and external voltage or a contact opening/closing. Digital Inputs can be used to set the instrument in to different states. Possible uses are Reset Peak Reading, Reset set Alarm, Perform zero calibration, Start/Stop data recording, Set Point select, Auto/Manual control select, PID output select, Engage Pre-Tune and Engage Self-Tune.

Also refer to: Active Set point, Control Enable, Data Recording, Manual Mode.

Direct Acting Control

Direct action is required for applications where the primary control output will be used to force the process variable down towards the set point. A typical application is a Chiller. When the control action is selected as direct acting, primary proportional control outputs decrease the correcting variable as the process variable reduces within the proportional band, and primary On-Off outputs turn off when the process variable is less than the set point. The control action of a secondary output is always the opposite of the primary output.

Also refer to: Control Action, Control Type, Correcting Variable, On-Off Control, Process Variable, Proportional Control and Reverse Acting Control.

Display Configuration

A sub-menu of Configuration Mode used to adjust the display, and the parameters that relate to Operation Mode (Custom display enable, read-only operation mode, bar-graph formatting, trend setup, and display colour & contrast and language selection).

Also refer to: Bar-Graphs, Configuration Mode, Custom Display Mode, Operation Mode, Main Menu and Trend Display.

Display Resolution

The maximum number of digits that can be displayed and/or the maximum number of decimal places. Numeric values (e.g. process variable, set points etc) are limited to no more than 5 digits.

The maximum number of decimal places is selectable from 0 to 3 places, but the overall 5-digit limit means that larger values may not display the full number of decimal places. For example, values >99.999 can have no more than 2 decimal places (e.g. 100.00).

Also refer to: LSD

Effective Set point

- Refer to *Actual Set point*.

Engineering Units

The Process Variable and Set point displays can assign engineering units to describe the type of parameter connected to the process input. The engineering units for linear inputs can be: °C; °F; °K; bar; %; %RH; pH; psi or none. For temperature inputs (RTD or Thermocouples) they can be °C; °F or °K.

Also refer to: Linear Input, Process Input, Process Variable RTD and Thermocouple

Ethernet

A networking technology for local area networks (LANs). Used to link computers and other equipment in order to control or share data and control such devices. If fitted with an Ethernet serial communications module in Option Slot A, this instrument can connect to a Modbus TCP master device over a wired Ethernet LAN.

Also refer to: Modbus TCP and Serial Communications

Indicator

An instrument that displays process values, but lacks control features. Typically, alarm outputs are available that will activate at preset PV values.

Also refer to: Controller, Limit Controller and Process Variable.

Input Configuration

A sub-menu of Configuration Mode, used to adjust the parameters that relate to the process and auxiliary inputs (type, engineering units, decimal position, scaling, offset, filter auxiliary input settings etc.).

Also refer to: Auxiliary Input, Configuration Mode and Process Input.

Input Filter Time Constant

This parameter is used to filter out extraneous impulses affecting the process variable value. The filtered PV is used for all PV dependent functions (display, control, alarm etc). Use this parameter with care as it will also slow the response to genuine process changes.

Settings = 0.5 to 100.0 seconds.

Default value = 1.0 seconds.

Also refer to: Process Variable.

Input Range

This is the overall process variable input range and type as selected by the Process Input Type parameter. This range can be scaled by the Scale Range Upper & Lower Limits.

Also refer to: Input Span, Process Input, Scale Range Lower Limit and Scale Range Upper Limit.

Input Span

The measuring and display limits, as defined by the Scale Range Lower and Scale Range Upper Limits. The trimmed span value is also used as the basis for calculations that relate to the span of the instrument (e.g. proportional bands).

Settings = 100 LSD's to the full Input Range.

Default value = Input Range

Also refer to: Input Range, LSD, Primary Proportional Band, Scale Range Lower Limit, Scale Range Upper Limit and Secondary Proportional Band.

Integral Time Constant

Integral action biases proportional control output(s) to compensate for process load variations, until the control deviation value is zero. Integral Time Constant is also known as "Automatic Reset". Decreasing the time constant increases the Integral action. This parameter is not available if the primary output is set to On-Off.

Settings = 1 sec to 99 min 59 sec and OFF.

Default value = 05:00

Also refer to: Control Deviation, On-Off Control, PI Control, PI, Primary Proportional Band, Secondary Proportional Band, Derivative Action, and Tuning.

Latching Relay

A type of relay that, once it becomes active, requires a reset signal before it will deactivate. If latching relays are required, they can be fitted externally as slaves to the internal (non-latching) relays of this instrument.

Also refer to: Relay

LED

Light Emitting Diode. LED's are used as indicator lights (e.g. for the alarm indication, automatic tuning stats and manual mode).

Also refer to: Alarm Operation, Alarm Types, Automatic Tuning and Manual Mode.

Linear Input

An mVDC, mADC or voltage signal used to represent the value of the process variable. This can be any variable that can be converted into a suitable DC linear signal. Common examples are Humidity, pressure, pH or temperature.

Auxiliary linear inputs can also be installed; these can be used to provide a remote set point.

Also refer to: Auxiliary Input, Input Range, Linear Output, mVDC, mADC, Process Variable, Remote Set point and VDC.

Linear Output

A mVDC, mADC or voltage signal used to provide a proportional control or retransmit output.

Also refer to: Linear Input mVDC, mADC, Proportional Control, Retransmit Output and VDC

Limit Controller

A safety protection device that will shut down a process at a preset "exceed condition". Limit controllers work independently of the normal process controller in order to prevent possible damage to equipment or products. A fail-safe latching relay is fitted, which cannot be reset by the operator until the process has returned to a safe condition. Limit controllers are highly recommended for any process that could potentially become hazardous under fault conditions.

Also refer to: Controller and Latching Relay.

Local Set points

Local set points are target values that are stored inside the controller. These are normally entered by from the front keypad, but can also be set via a serial communications link.

The value of the set point can be adjusted between the Set point Upper Limit and Set point Lower Limits.

Also refer to: Alternative Set point, Auxiliary Input, Remote Set point, Serial Communications, Set point, Set point Lower Limit, Set point Upper Limit, and Set point Select.

Lock Codes

The four-digit codes required when entering the Setup Wizard, Configuration Mode, Tuning Menu, Supervisor Mode, USB Menu, Recorder Menu. These menus can be selected from the Main Menu. The correct code must be entered to gain access. If unlimited access is required for any of the menus, its lock can be turned off by setting the value to OFF. *Refer to the Lock Code View information in the Configuration & Use section.*

Settings = 1 to 9999 or OFF.

Default value = 10

Also refer to: Configuration Mode, Main Menu, Recorder Menu, Setup Wizard, Supervisor Mode, Tuning Menu and USB Menu.

Logical Combination of Alarms

Outputs for alarms may be combined to create a Logical OR situation. Possible OR combinations are: Alarms 1 to 2; 1 to 3.

Any suitable output may be assigned as a logical output and can be configured for reverse action or direct action. The following table explains the concept of logical OR & AND outputs.

Also refer to: Alarm Operation, Alarm Types, Output Configuration.

Table 24. Examples Of Logical Alarm Outputs

Logical OR: Alarm 1 OR Alarm 2										
Direct Acting					Reverse-Acting					
ALARM 1	OFF	ALARM 2	OFF	OUTPUT	OFF	ALARM 1	OFF	ALARM 2	OUTPUT	ON
	ON		OFF		ON		OFF			OFF
	OFF		ON		ON		ON			ON
	ON		ON		ON		ON			OFF

Logical AND: Alarm 1 AND Alarm 2										
Direct Acting					Reverse-Acting					
ALARM 1	OFF	ALARM 2	OFF	OUTPUT	OFF	ALARM 1	OFF	ALARM 2	OUTPUT	ON
	ON		OFF		OFF		ON			ON
	OFF		ON		OFF		OFF			ON
	ON		ON		ON		ON			OFF

Loop Alarm

A loop alarm detects faults in the control feedback loop, by continuously monitoring process variable response to the control output(s). If one of the 5 alarms is defined to be a loop alarm, it repeatedly checks if the PI control output is at saturation. If saturation is reached (0% or 100% power for single control type, -100% or +100% for dual control type), an internal timer is started. Thereafter, if the output has not caused the process variable to be corrected by a predetermined amount 'V' after time 'T' has elapsed, the alarm becomes active. Subsequently, the alarm repeatedly checks the process variable and the PI output. When the process variable starts to change value in the correct sense or when the PI output is no longer at the limit, the alarm is deactivated.

For PI control, the loop alarm time 'T' can be automatic (twice the Integral Time value) or set to a user defined value. Correct operation with the automatic loop alarm time depends upon reasonably accurate PI tuning. The user defined value is always used for On-Off control, and the timer starts as soon as an output turns on.

The value of 'V' is dependent upon the input type. For Temperature inputs, V = 2°C or 3°F. For Linear inputs, V = 10 x LSD

The loop alarm is automatically disabled during manual control mode and during execution of a Pre-Tune. Upon exit from manual mode or after completion of the Pre-Tune routine, the loop alarm is automatically re-enabled.

Also refer to: Alarm Types, Control Type, Manual Loop Alarm Time, Linear Input, LSD, Manual Mode, On-Off Control, PI, Pre-Tune, Process Variable and Tuning.

LSD

The Least Significant Digit (LSD) is the smallest incremental value that can be shown at the defined display resolution.

Also refer to: Display Resolution.

mADC

This stands for milliamp DC. It is used in reference to the linear DC milliamp input ranges and the linear DC milliamp outputs. Typically, these will be 0 to 20mA or 4 to 20mA.

Also refer to: Input Range, Linear Input, Linear Output,, mVDC, Process Variable and VDC

Main Menu

The top-level menu that allows access to operation mode as well as all other menus. These are: configuration mode and recorder menus, the setup wizard, supervisor mode and the tuning and USB menus. Most menus require an unlock code to gain access.

Refer to the Main Menu information in the Configuration & Use section.

Also refer to: Configuration Mode, Lock Codes, Operation Mode, Recorder Menu, Setup Wizard, Supervisor Mode, Tuning Menu and USB Menu.

Manual Loop Alarm Time

The loop alarm time used when a loop alarm is defined to have a manually set time or whenever On-Off control is selected. This parameter determines the duration of the output saturation condition after which the loop alarm will be activated.

Settings = 1 sec to 99 mins 59 sec.

Default value = 99:59.

Also refer to: Loop Alarm, and On-Off Control.

Manual Mode

If Manual Mode is enabled/disabled (from the control configuration sub-menu, or the Auto/manual screen in operation mode if it is available) it allows the controller to switch between automatic and manual control modes. Auto/Manual Mode can also be switched using a digital input if one has been configured for this function. Switching between automatic and manual modes is achieved using “bumpless transfer”.

Manual Mode operates as follows:

The set point legend is replaced by the word **MAN** and set point value is replaced by a % output power value. This value may be adjusted using the ▼ or ▲ keys. The power value can be varied from 0% to 100% for controllers using single control type, and -100% to +100% for controllers using dual control type. It is possible to use a controller as a permanent “Manual Station” by selecting Manual Control in the control configuration sub-menu.

Caution: Manual Mode should be used with care because the power output level is set by the operator, therefore the PI algorithm is no longer in control of the process. The operator

MUST maintain the process at the desired level manually. Manual power is not limited by the Power Output Limits.

Also refer to: Bump less Transfer, Control Configuration, Control Type, Operation Mode, PI, and Power Output Limits.

Master & Slave Controllers

The terms master and slave are used to describe the controllers in multi-zone applications where one instrument controls the set point of another. These can be simple Set point Master/Slave applications where the master controller transmits its set point to the slaves via serial communications, or retransmits it as an analogue DC linear output signal. If serial comms are used, the master controller must be able to act as a communications master device and the slave must have a compatible communications option fitted. If DC linear retransmission is use, the slave controller must have a matching a remote set point input. It is possible to apply an offset to each zone if the slave has a Set point offset parameter or by offsetting its remote set point input (or adjusting the scaling of this input).

Cascade Control is another type of Master & Slave application where the slave's set point is set using the master controllers PI power output.

The terms Master and Slave are also used in a different context in relation to serial communications.

Also refer to: Cascade Control, Linear Output, Retransmit Output, Remote Set point, Auxiliary Input Offset, Serial Communications and Set point.

Minimum Duration Of Change

A form of alarm hysteresis unique to the Rate Of Change Alarm. It is the minimum time that the rate of change in the process variable must be above the alarm threshold, before the alarm will change state (from on to off, or off to on).

Settings = 1 to 9999 secs.

Default value = 1sec.

Caution: If the duration is less than this time, the alarm will not activate no matter how fast the rate of rise.

Also refer to: Alarm Hysteresis, Alarm Types and Rate Of Change Alarm.

Modbus RTU

Modbus RTU is the serial communications protocol used on instruments fitted with the RS485 Communications module into Option Slot A. Alternatively, the Modbus TCP protocol is available if the Ethernet Communications Module is fitted.

Modbus RTU is a Master/Slave protocol. Only the Master may initiate communications. Each slave is given a unique address, and the message contains the Modbus address of the intended slave. Only this slave will act on the command, even though other devices might receive it (an exception is specific broadcast commands sent to address 0 which are acted upon by all slaves but not acknowledged).

The commands can instruct the slave to change a value in one of its registers, or ask it to send back one or more values contained in its registers. The Modbus RTU format follows the messages with a cyclic redundancy check (CRC) checksum to ensure that the message arrives undamaged.

This instrument can act as a Slave or as a Set point Master over RS485. In this mode the unit continuously sends its set point value using Modbus broadcast messages.

Refer to the Serial Communications and Modbus Parameter sections of this manual for more information.

Also refer to: Modbus TCP, RS485 and Serial Communications.

Modbus TCP

Modbus TCP is a version of the Modbus protocol for networks that support the Internet Protocol, such as Ethernet. It is available if the Ethernet Communications Module is fitted into Option Slot A.

This instrument can only act as a Slave when using Modbus TCP. A master device initiates the communications, and the instrument only acts on the command if it has been sent to its IP address. The data model and function calls used by Modbus TCP and RTU are identical; only the encapsulation is different. Modbus/TCP does not require a checksum to ensure that the message arrives intact.

Refer to the Serial Communications and Modbus Parameter sections of this manual for more information.

Also refer to: Ethernet, Modbus RTU and Serial Communications.

Modulating Valve

A valve that can be positioned anywhere between fully closed and fully open by means of an incorporated motor. A typical application would be controlling temperature in a furnace heated by gas burners. This instrument can control modulating valves that have a positioning circuit. These require proportional (mA or VDC) control signal from a linear output, relative to the desired valve position. PI control is used for valve control.

To directly control the valves 'open' and 'close' motor windings, a special Valve Motor Drive (VMD) controller algorithm is required. This instrument does not currently support this type of algorithm.

Also refer to: Linear Output, PI Control, Proportional Control and Valve Motor Drive Control.

Multi-Point Scaling

If the process input is connected to a linear input signal, multi-point scaling can be enabled in the Input Configuration sub-menu. This allows the linearization of a non-linear signal.

The Scale Range Upper & Lower Limits define the values shown when the input is at minimum and maximum values, and up to 15 breakpoints can scale input vs. displayed value between these limits. It is advisable to concentrate these break points in the area of the range that has the greatest amount of non-linearity, or the area of particular interest in the application.

Also refer to: Input Configuration, Linear Input, Process Input, Scale Range Lower Limit and Scale Range Upper Limit.

mVDC

This stands for millivolt DC. It is used in reference to the linear DC millivolt input ranges. Typically, these will be 0 to 50mV or 10 to 50mV

Also refer to: Auxiliary Input, Input Range, Linear Input, mADC, Process Variable and VDC

On-Off Control

When operating in On-Off mode, the control output(s) will turn on or off as the process variable crosses the set point in a manner similar to a central heating thermostat. Some oscillation of the process variable is inevitable when using On-Off control.

On-Off control can be implemented only with Relay or SSR driver outputs. On-Off operation can be assigned to the Primary output alone (secondary output not present), Primary and Secondary outputs or Secondary output only (with the primary Output set for time proportional or current proportional control). On-Off Control is selected by setting the corresponding proportional band(s) to On-Off.

Also refer to: On-Off Differential, PI, Process Variable, Primary Proportional Band, Secondary Proportional Band, Relay, Set point, SSR Driver, Time Proportioning Control and Triac.

On-Off Differential (On-Off Hysteresis)

A switching differential, centred about the set point, when using On-Off control. Relay 'chatter' can be eliminated by proper adjustment of this parameter, but too large a value may increase process variable oscillation to unacceptable levels. On-Off differential is also known as hysteresis or dead band.

Settings = 0.1% to 10.0% of input span.

Default value = 0.5%.

Also refer to: Input Span, On-Off Control, Process Variable, Relay and Set point

Operation Mode

The mode used during normal operation of the instrument. It can be accessed from the Main Menu, and is the usual mode entered at power-up. The screens shown include a main screen with bar-graph, a trend view, information about the process, alarms plus optionally, selection of auto/manual control, control output disabling. Recorder and profiler information can be displayed if these features are fitted. Up to 50 configuration menu screens can be defined with the PC software, and will be shown if the Custom Display mode is enabled in the Display Configuration sub-menu.

Refer to the Operation Mode information in the Configuration & Use section.

Also refer to: Bar-Graphs, Configuration Mode, Custom Display Mode, Display Configuration, Main Menu, Recorder Menu. and Trend Display.

Output Configuration

A sub-menu of Configuration Mode used to adjust the parameters that relate to the Outputs (Linear output type & scaling, output usage and scaling etc).

Also refer to: Configuration Mode and Linear Output.

Overlap/Dead band

The Overlap/Dead band parameter defines the portion of the primary and secondary proportional bands over which both outputs are active (called Overlap), or neither is active (called Dead band). This is adjustable in the range -20% to +20% of the sum of the two proportional bands. Positive values = Overlap, negative values = Dead band.

Overlap/dead band is applicable if the primary output is set for On-Off control or there is no Secondary Output. If the Secondary Output is set for On-Off, this parameter has the effect of moving the On-Off Differential band of the Secondary Output to create the overlap or dead band. When Overlap/Dead band = OFF, the edge of the Secondary Output Differential band coincides with the point at which the Primary Output = 0%.

The effect of the Overlap/Dead band parameter is shown in the following table

Settings = -20% to +20%.

Default value = 0.

Also refer to: On-Off Differential, On-Off Control, Primary Proportional Band and Secondary Proportional Band.

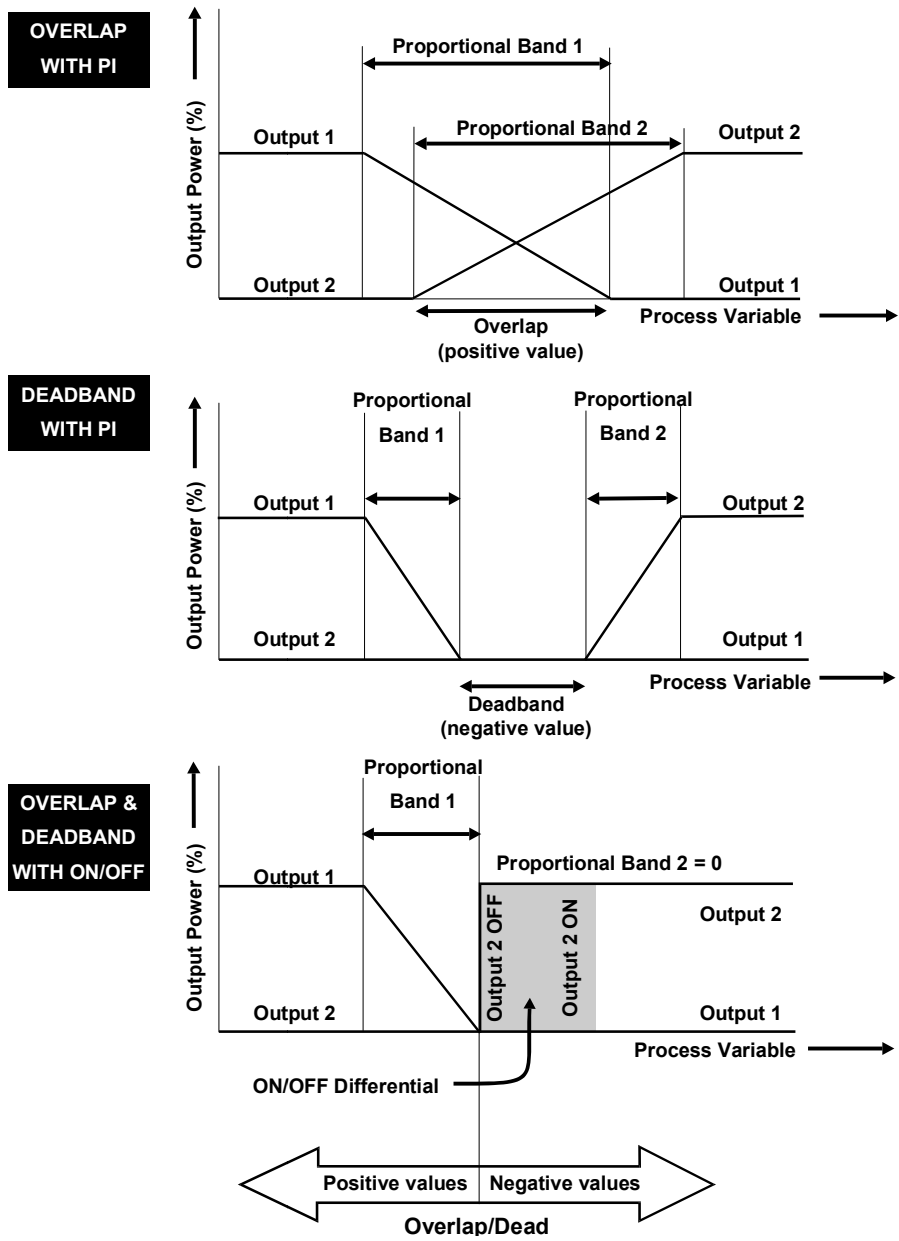

Figure 25. Overlap/Dead band

PI Control

Proportional and Integral Control (PI) is most often used for modulating valve or motor control. It combines proportional control with integral action. It is similar to PI Control, but without derivative action that can cause excessive valve movement.

Also refer to: Derivative, Integral, Modulating Valve, PI Control, Proportional Control and Tuning.

PI Control

Proportional Integral control maintains accurate and stable levels in a process (e.g. when controlling a temperature). Proportional Control avoids the oscillation characteristic of On-Off control by continuously adjusting the correcting variable output(s) to keep the process variable stable. Integral action eliminates control deviation errors.

Also refer to: Control Action, Control Deviation, Control Enable, Control Type, Controller, Correcting Variable, Derivative Action, Integral Action, Manual Mode, On-Off Control, PD Control, PI Control, Primary Proportional Band, Process Variable, Secondary Proportional Band, Set point and Tuning.

PLC

This stands for Programmable Logic Controller. A microprocessor based device used in machine control. It is particularly suited to sequential control applications, and uses "Ladder Logic" programming techniques. Some PLC's are capable of basic PI control, but tend to be expensive and often give inferior levels of control.

Also refer to: PI.

Pre-Tune

The Pre-Tune facility artificially disturbs the start-up pattern so that a first approximation of the PI values can be made prior to the set point being reached. During Pre-Tune, the controller outputs full Primary Power until the process value has moved approximately halfway to the set point. At that point, power is removed (or full Secondary Power is applied for Dual Control), thereby introducing an oscillation. Once the oscillation peak has passed, the Pre-Tune algorithm calculates an approximation of the optimum PI tuning terms proportional band(s), integral and derivative. The Pre-Tune process is shown in the diagram on the next page.

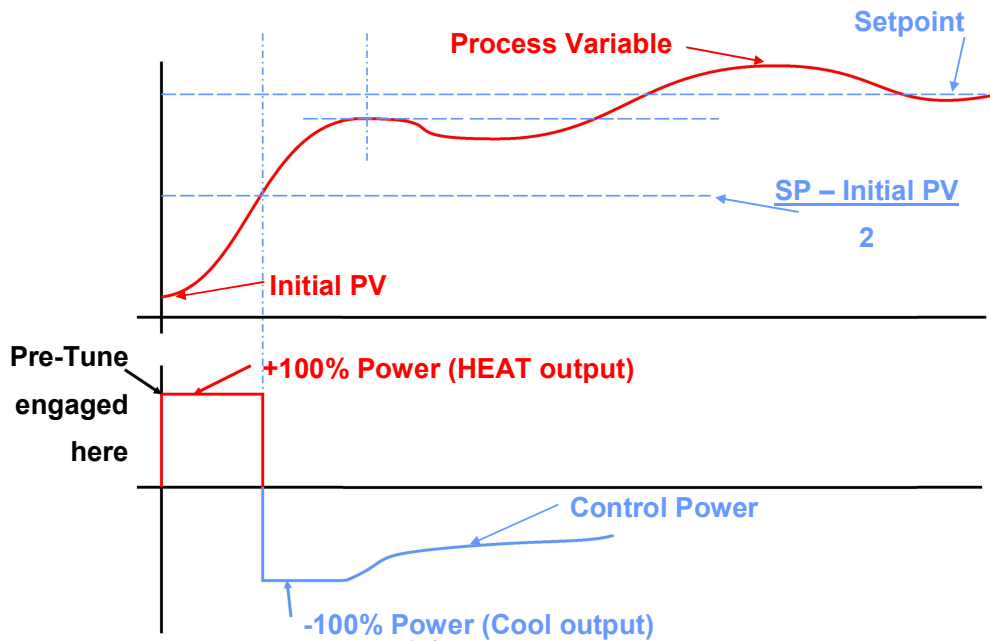

Figure 26. Pre-Tune Operation

When Pre-Tune is completed, the PI control output power is applied using the calculated values. Pre-Tune limits the possibility of set point overshoot when the controller is new or the application has been changed.

Pre-Tune can be selected from the Automatic Tuning Menu. It will not engage if either primary or secondary outputs on a controller are set for On-Off control, during set point/profile ramping or if the process variable is less than 5% of the input span from the set point. As a single-shot operation, Pre-Tune will automatically disengage once complete, but can be configured to run at every power up using the Auto Pre-Tune function.

Also refer to: Auto Pre-Tune, Control Type, Derivative Action, On-Off Control, Input Span, , Integral, PI, Primary Proportional Band, Process Variable, Secondary Proportional Band, Self-Tune, Set point, Set point Ramping, and Tuning.

Power Output Limits

Used to limit the power levels of the primary and secondary control outputs. Normally the instrument can set these outputs to any value between 0% and 100%. If this is undesirable in a particular application, individual settings can limit the primary power upper and lower levels and the secondary power upper and lower levels. The upper limit values must be higher than the lower limits. These parameters are not applicable if that output is set for On-Off control.

Use with caution: The instrument will not be able to control the process if the limits do not allow the outputs to be set to the correct values to maintain set point.

Lower Limit settings = 0% and 100%

Default Value = 0%.

Upper Limit settings = 0% and 100%

Default Value = 100%.

Also refer to: Control Type, On-Off Control and Set point.

Primary Proportional Band

The portion of the input span over which the Primary Output power level is proportional to the process variable value. Applicable if Control Type is single or dual. For dual control a Secondary Proportional band is used for the second output. The Control Action can be Direct or Reverse acting.

Settings = On-Off Control or 0.5 to 999.9

Default Value = 10.

Also refer to: Control Action, Control Type, On-Off Control, Input Span, Overlap/Dead band, PI, Secondary Proportional Band, and Tuning.

Process High Alarm *n* Value

An independent high alarm value parameter is available for each alarm that is set as Process High type. It defines the process variable value above which Alarm *n* will be active.

Settings = Scale Range Upper to Lower Limit Default Value = Scale Range Upper Limit.

Also refer to: Alarm Operation, Alarm Types, Process Variable, Scale Range Lower Limit and Scale Range Upper Limit.

Process Input

The main input used to monitor the value process to be controlled. This is known as the Process Variable or PV. The input circuit is a "Universal" type, supporting Strain gages and all common thermocouples and PT100 RTDs as well as DC linear mV, voltage or mA signals suitable for almost any parameter that can be converted into a electronic signal. Linear signals can be scaled into engineering units using the Scale Range Lower Limit and Scale Range Upper Limit parameters.

Also refer to: Auxiliary Inputs, Engineering Units, Input Span, PV Offset, Process Variable , Scale Range Lower Limit and Scale Range Upper Limit.

Process Low Alarm *n* Value

An independent low alarm value parameter is available for each alarm that is set as Process Low type. It defines the process variable value below which Alarm *n* will be active.

Settings = Scale Range Upper to Lower Limit Default Value = Scale Range Lower Limit.

Also refer to: Alarm Operation, Alarm Types, Process Variable, Scale Range Lower Limit and Scale Range Upper Limit.

Process Variable (PV)

Process Variable is the parameter that is to be controlled. It is monitored by the main process input of the instrument, and can be any type that can be measured by that circuit. Common types are Thermocouple or RTD temperature probes, or pressure, level, flow etc from transducers that convert these parameters into DC linear input signals (e.g. 4 to 20mA). Linear signals can be scaled into engineering units using the Scale Range Lower Limit and Scale Range Upper Limit parameters.

Also refer to: Actual Set point, Engineering Units, Input Span, Linear Input, Process Input, RTD, Scale Range Lower Limit, Scale Range Upper Limit and Thermocouple.

Process Variable Offset

The Process variable offset is used to modify the measured process variable value. Use this parameter to compensate for errors in the displayed process variable. Positive values are added to the process variable reading, negative values are subtracted. **Caution:** This parameter is in effect, a calibration adjustment; it must be used with care. Injudicious use could lead to the displayed value bearing no meaningful relationship to the actual process variable. There is no front panel indication of when this parameter is in use.

Settings = \pm input span

Default Value = Off.

Also refer to: Input Span and Process Variable.

Proportional Control

Proportional control allows the correcting variable applied to the process to be set between 0 and 100% of the amount available. If the control type is dual, two outputs (primary & secondary) are available, each of which can give proportional control. When the Proportional Band(s) are correctly tuned, the process variable is maintained at a steady value, avoiding the oscillation characteristic of On-Off control. Proportional control is most commonly used in conjunction with Integral and Derivative action to give PI, PD or PID control.

Also refer to: Control Type, Correcting Variable, Derivative Action, Integral Action, On-Off Control, PD, PI, PID, Primary Proportional Band, Process Variable, Secondary Proportional Band, Set point and Tuning.

Rate

- Refer to *Derivative Action*.

Rate Of Change Alarm

An alarm based on the rate of change in the measured process variable. If the PV changes at a rate greater than the alarm level, the alarm will activate. The rate of change must be above the alarm threshold for longer than the Minimum Duration Of Change time, before the alarm will change state (from on to off, or off to on). **Caution:** If the duration is less than this time, the alarm will not activate no matter how fast the rate of rise.

Also refer to: Alarm Hysteresis, Alarm Operation, Alarm Types, Minimum Duration Of Change and Process Variable.

Recorder Configuration

If the Data Recorder is fitted, a Recorder Configuration sub-menu is added to Configuration Mode. This is used to adjust the recorder parameters (Recording mode, sample interval, trigger and values to record) and to show the recorder status.

Also refer to: Configuration Mode, and Data Recorder

Recorder Option

- Refer to *Data Recorder*.

Recorder Menu

If the Data Recorder is fitted, a Recorder Menu is added to the Main Menu. This is used to control the recording (start, stop, delete recordings etc) and to show the recorder status. This menu is protected by a lock code.

Refer to the Recorder Menu information in the Configuration & Use section.

Also refer to: Process Variable, Retransmit Output, Retransmit Output n Scale Maximum, Scale Range Lower Limit and Set point.

Reset To Defaults

This Configuration sub-menu selection returns all of the instruments settings back to their factory defaults. It should be used with great care, as the action cannot be undone. A reset is followed automatically by the Setup Wizard. Users must use this wizard and/or configuration menus to set all of the parameters to the correct values for the intended application.

Also refer to: Configuration Menu, and Setup Wizard

Reverse Acting Control

Reverse control action is required for applications where the primary control output will be used to force the process variable up towards the set point. A typical application is a furnace. When the control action is selected as reverse acting, primary proportional control outputs decrease the correcting variable as the process variable increases within the proportional band, and primary On-Off outputs turn off when the process variable exceeds the set point. The control action of a secondary output is always the opposite of the primary output.

Also refer to: Control Action, Control Type, Correcting Variable, Direct Acting Control, On-Off Control and Proportional Control.

RS485

RS485 (also known as EIA-485) is two-wire, half-duplex, multi-drop serial communications connection. RS485 only defines the physical layer electrical specification, not the protocol that is transmitted across it. It uses differential signals (the voltage difference between the wires) to convey data. One polarity indicates a logic 1, the reverse polarity indicates logic 0. The applied voltages can be between +12 V and -7 volts, but the difference of potential must be > 0.2 volts for valid operation. RS485 can span distances up to 1200 metres using inexpensive twisted pair wires. Data speeds can be as high as 35 Mbit/s over 10 m and 100 kbit/s at 1200 m.

It is recommended that the wires be connected as series of point-to-point (multi-dropped) nodes (not in a star or ring format), with 120ohm termination resistors connected across the wires at the two ends of the network. Without termination resistors, reflections of the signals can cause data corruption, and electrical noise sensitivity is increased. The master device should normally provide powered resistors, to bias the wires to known voltages when they are not being driven by any device. Without biasing resistors, the data lines float and noise can be interpreted as data when actually all devices are silent.

Converters between RS485 and other formats are available to allow computers to communicate with remote devices. Repeaters can also be used to extend the distance and/or number of nodes on a network.

Also refer to: Modbus RTU, and Serial Communications

RTD

Resistance Temperature Detector. A temperature sensor that changes resistance with a change in the measured temperature. This instruments process input supports PT100 (platinum, 100 Ω at 0°C) and NI120 (nickel, 120 Ω at 0°C) sensors. These have positive temperature coefficients (PTC) which means their resistance increases with higher temperatures. The temperature measured by the sensor can be displayed as °C; °F or °K.

Also refer to: Input Range, Process Input and Thermocouple.

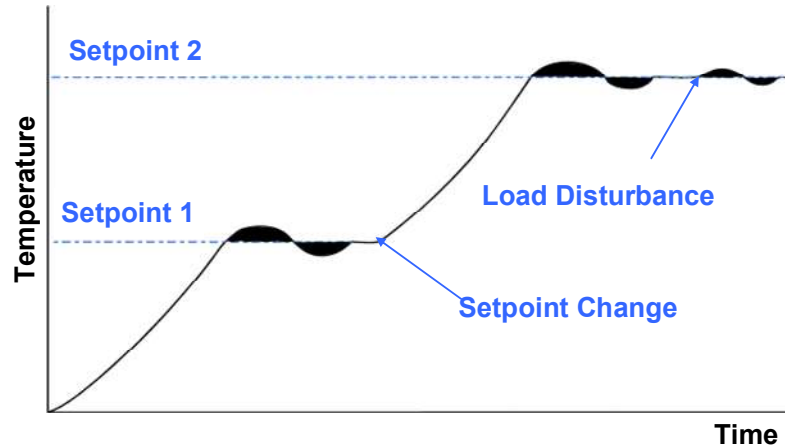

Figure 27. Self-Tune Operation

The deviation signal is shown shaded, and overshoots have been exaggerated for clarity. The Self-Tune algorithm observes one complete deviation oscillation before calculating a new set of PI values. Successive deviation oscillations cause the values to be recalculated so that the controller converges on optimal control. When the controller is switched off, these PI terms are stored, and are used as starting values at the next switch on. The stored values may not always be ideal, if for instance the controller is brand new or the application has changed. In these cases, the user can utilise Pre-Tune to establish new initial values. Self-Tune will then fine-tune these values as it monitors any control deviation.

Use of continuous self-tuning is not always appropriate. For example applications which are frequently subjected to artificial load disturbances, for example where an oven door is likely to be frequently left open for extended periods, can lead to errors in the calculations. In addition, because Self-Tune tunes for full PI control, it is not recommended for valve control applications, which normally require PI control.

Self-Tune cannot be engaged if the instrument is set for On-Off Control.

Also refer to: Control Deviation, Modulating Valves. On-Off Control, Pre-Tune, PI, PI, Set point and Tuning.

Sensor Break Pre-Set Power

If a thermocouple or RTD breaks, or it is disconnected, the instrument detects this condition within 2 seconds, and sets the control output(s) to the value defined by the Sensor Break Pre-Set Power Output parameter in the Control Configuration sub-menu. Process alarms behave as though the PV has gone high.

Non-zero based linear inputs (e.g. 2 to 10V or 4 to 20mA, but not 0 to 20mA) can also detect a sensor break condition, setting the power to the Pre-Set Power value. Process alarms behave as though the PV has gone low.

Also refer to: Input Range, Linear Input, RTD and Thermocouple.

Serial Communications Configuration

A sub-menu of Configuration Mode used to adjust the serial communications parameters. (Addressing, data rate, parity, master/slave settings and write enabling).

Also refer to: Configuration Mode, Serial Communications

Serial Communications Option

A feature that allows other devices such as PC's, PLC's or a master controller to read, or change the instruments parameters via an RS485 or Ethernet network.

Full details can be found in the Serial Communications sections of this manual.

Also refer to: Ethernet, Master & Slave, Modbus RTU, Modbus TCP, PLC, RS485 and Serial Communications Configuration.

Set point

The target value at which the instrument attempts to maintain the process variable, by adjusting its control output power (the correcting variable). The setpoint can be Local (set from the keypad, or Remote (set by the Auxiliary Input if fitted) One set point can be chosen as active using the defined Set point Selection method. Set point values are limited by the Set point Upper Limit and Set point Lower Limits.

Also refer to: Alternative Set point, Auxiliary Input, Correcting Variable, Local Set points, Process Variable, Remote Set point, Scale Range Lower Limit, Set point Lower Limit, Set point Upper Limit and Set point Select

Set point Upper Limit

The maximum value allowed for set points. It should be set to keep the set point below a value that might cause damage to the process. The adjustment range is between Scale Range Upper Limit and the Set point Lower Limit. If the value is moved below the current value of a set point, that set point will automatically adjust to keep within bounds.

Settings = Within Input Span

Default Value = Scale Range Upper Limit

Also refer to: Input Span, Scale Range Upper Limit, Set point and Set point Lower Limit.

Set point Lower Limit

The minimum value allowed for set points. It should be set to keep the set point above a value that might cause damage to the process. The adjustment range is between the Set point Upper Limit and the Scale Range Lower Limit. If the value is moved above the current value a set point, that set point will automatically adjust to keep within bounds.

Settings = Within Input Span

Default Value = Scale Range Lower Limit

Also refer to: Input Span, Scale Range Lower Limit, Set point and Set point Upper Limit.

Set point Ramp Editing

Enables or disables the viewing and adjustment of the set point ramp rate in Operation Mode. This parameter does not disable the ramping SP feature; it merely removes it from Operation Mode. It can still be viewed and adjusted in the Control Configuration sub-menu. To turn off ramping, the ramp rate must be set to OFF.

Settings = Enabled or Disabled

Default Value = Disabled

Also refer to: Control Configuration, Operation Mode, Process Variable, Set point and Set point Ramp Rate.

Set point Ramp Rate

The rate at which the actual set point value will move towards its target value, when the set point value is adjusted or the active set point is changed. With ramping in use, the initial value of the actual set point at power up, or when switching back to automatic mode from manual control, will be equal to the current process variable value. The actual set point will rise/fall at the ramp rate set, until it reaches the target set point value. Set point ramping is used to protect the process from sudden changes in the set point, which would result in a

raPI rise in the process variable.
Settings = 1 to 9999 LSDs per hour.

Default Value = OFF

Also refer to: Active Set point, Actual Set point, LSD, Manual Mode, Process Variable, Set point, Set point Ramp Editing and Set point Selection.

Set point Selection

There can be two setpoint sources, Local Setpoint 1, or a Remote Setpoint from the Auxiliary Input if fitted. The Set point Select parameter in the control sub-menu defines whether the Active Set point will be the Local Set point 1 only, the Alternative Set point only or if the choice of active set point will be made from a digital input or an Operation Mode selection screen.

Also refer to: Active Set point, Alternative Set point, Auxiliary Input, Set points, Remote Set point, Set point.

Setup Wizard

A sub-set of the Configuration Menu parameters chosen to allow inexperienced users to easily set the instrument up for most simple applications. The parameters shown depend on the options installed.

The Setup Wizard runs automatically at first ever power-up or whenever a Reset To Defaults is carried out. A partial Wizard also runs whenever option modules have been changed. The partial wizard only shows parameters affected by the changes made. The full Setup Wizard can also be run manually from the Main Menu (this requires entry of an un-lock code). Once completed, the Setup Wizard exits to Operation Mode.

Experts or users with more complex applications should select the parameters they wish to set-up from the Configuration Menus instead of using the Wizard.

Refer to the Setup Wizard information in the Configuration & Use section.

Also refer to: Lock Codes, Configuration Menu, Main Menu, Operation Mode and Reset To Defaults.

Solid State Relay (SSR)

An external device manufactured using two Silicone Controlled Rectifiers in reverse parallel. They can be used to replace mechanical relays in most AC power applications. Some special SSRs can switch DC, but most cannot. As a solid-state device, an SSR does not suffer from contact degradation when switching electrical current. Much faster switching cycle times are also possible, leading to superior control. The instrument's SSR Driver output provides a time-proportioned 10VDC pulse for to the SSRs signal input terminals. This causes conduction of current from the line supply through the SSR to the load, when the pulse is on.

Also refer to: Cycle Time, Time Proportioning Control, Relay, and Triac.

Supervisor Mode

Supervisor Mode allows access to a lock code protected sub-set of the main configuration parameters. The unlock code is different from the higher level Configuration Menu unlock code. Up to 50 Configuration Menu parameters can be chosen for inclusion in Supervisor Mode using the PC configuration software. If none have been chosen, this mode is disabled.

Refer to the Supervisor Mode information in the Configuration & Use section.

Also refer to: Configuration Menu and Lock Codes

Thermocouple

A temperature sensor made from two different metals. They convert temperature difference between their cold junction (the measuring instrument) and the hot junction, into a small signal or a few microvolts per °C. Thermocouples are cheap and interchangeable, but the wires and connectors used must match the metals used in their construction. They can measure a wide range of temperatures; some thermocouples can withstand very high temperatures such as furnaces. The main limitation of thermocouples is accuracy. The temperature measured by the thermocouple can be displayed as °C; °F or °K.

The colour codes for the common types are shown in the Thermocouple Wire Identification Chart in the Electrical Installation Section of this manual.

Also refer to: Engineering Units, Input Range, Process Input and RTD.

Three Point Stepping Control

Modulating valves normally require a special “Three Point Stepping” control algorithm. This which provides an output to move the valve further open, or further closed whenever there is a control deviation error. When this error is zero, no further output is required to maintain control unless load conditions change. This type of controller is often called a Valve Motor Drive controller. This instrument does not currently have a three point stepping algorithm.

However, modulating valves that have a valve positioning circuitry to adjust the valve position from a DC linear mA or voltage output signal can be controlled.

Also refer to: Control Deviation, Linear Output, Modulating Valve, and Valve Motor Control

Time Proportioning Control

Time proportioning control is accomplished by cycling the output on and off during the prescribed cycle time, whenever the process variable is within the proportional band(s). The PI control algorithm determines the ratio of time (on vs. off) to achieve the level of the correcting variable required to remove the control deviation error. E.g. for a 32 second cycle time, 25% power would result in the output turning on for 8 seconds, then off to 24 seconds. This type of output might be used with electrical contractors, solid state relays or solenoid valves. Time proportioning control can be implemented with Relay, Triac or SSR Driver outputs for either primary or secondary outputs.

Also refer to: Control Deviation, Correcting Variable, Current Proportioning Control, Cycle Time, PI, Primary Proportional Band, Relay, Secondary Proportional Band, Solenoid Valve, SSR and Triac.

Trend Display

Trend View is a graphical representation of recent process conditions. This feature is available on all variants. It does not rely on the Data Recorder option, and does not retain the stored data if the power is turned off. The trend shows the most recent 120 out of 240 stored data points. Its scale adjusts automatically for the best resolution for the visible data. This data can be the process variable; process variable & set point (shown as a dotted line), or the minimum and maximum value of the process variable measured since the last sample. Any active alarm(s) are indicated above the graph. The user can scroll the right hand cursor line back to examine all 240 data points. The sample interval and data to display is set in Display Configuration.

Also refer to: Alarm Types, Display Configuration, Operation Mode, and Process Variable, Set point.

Tuning

PI Controllers must be tuned to the process in order for them to attain the optimum level of control. Adjustment is made to the tuning terms either manually, or by utilising the controller's automatic tuning facilities. Tuning is not required if the controller is configured for On-Off Control.

Also refer to: Auto Pre-Tune, Controller, Derivative Action, Integral Action, On-Off control, PI, Pre-Tune, Primary Proportional Band, Self-Tune, Secondary Proportional Band and Tuning Menu.

Tuning Menu

The Tuning Menu can be accessed from the Main Menu. This menu is lock code protected. It gives access to the Pre-tune, Auto Pre-Tune and Self-tune facilities. These assist with PI tuning, by setting up Proportional band(s), Integral and Derivative parameter values. Tuning is not required for On-Off control.

Pre-tune can be used to set PI parameters approximately. Self-tune may then be used to optimise the tuning if required. Pre-tune can be set to run automatically after every power-up by enabling Auto Pre-Tune.

Refer to the Automatic Tuning information in the Configuration & Use section.

Also refer to: Auto Pre-Tune, Derivative Action, Integral Action, Lock Codes, Main Menu, On-Off control, PI, Pre-Tune, Primary Proportional Band, Self-Tune, Secondary Proportional Band and Tuning Menu.

USB Menu

If the USB option is fitted, the USB Menu can be accessed from the Main Menu. This menu is lock code protected.

The USB Menu allows the user to read or write files to a USB memory stick. The current configuration of the instrument can be downloaded to the stick or the instrument can be completely reconfigured using a pre-stored file that has been downloaded earlier, created using the PC software, or even taken from another instrument.

If the Data Recorder option is present, the recordings can be downloaded to the stick for transport to the user's PC for analysis.

Refer to the USB Menu information in the Configuration & Use section.

Also refer to: Data Recorder, Lock Codes, Main Menu

Valve Motor Drive Control (VMD)

This instrument can only control modulating valves that have a valve positioning circuitry that adjusts the valve position according to the level a DC linear mA or voltage output signal.

Such valves normally require PI control instead of full PI.

Motorised modulating valves that do not have this type of circuit require special Valve Motor Drive controllers which have a "Three Point Stepping" control algorithm.

Solenoid valves can also be controlled using the standard PI algorithm as they behave in a similar way to relays, having just two states, open or closed.

Also refer to: Control Deviation, Linear Output, Modulating Valve, PI Control, PI, Relay, Solenoid Valve, and Three Point Stepping Control.

VDC

This stands for Volts DC. It is used in reference to the linear DC Voltage input ranges. Typically, these will be 0 to 5V, 1 to 5V, 0 to 10V or 2 to 10VDC. Linear outputs can also provide DC voltages.

Also refer to: Auxiliary Input, Input Range, Linear Input, Linear Output, mADC and mVDC..

VMD

- Refer to *Valve Motor Control*.

13 Appendix 2 – Automatic Stand-by (ATC990 Only)

Automatic stand-by Feature

The automatic stand-by function avoids overshoots following temporary process interruptions (i.e. if the pressure goes to zero) that may cause the controllers integral component to saturate. When the process restarts, a saturated output is likely to cause an excessive and potentially dangerous overshoot (starting the motor at full speed). This feature is not active while in manual control mode.

The parameters are:

1. Pressure Stand-by Threshold
Automatic stand-by pressure threshold value to switch controller into the automatic stand-by sequence (in physical units from 0 to 15 % of full scale or OFF). Input excursions of $[SP \pm \text{Threshold}]$ start the automatic stand-by feature.
If set to OFF, the automatic stand-by feature is disabled.
2. Pressure Stand-by Recovery Time
The maximum time (from 1 to 60 seconds) the automatic stand-by sequence is allowed to continue. If the excursion lasts longer than this time, manual mode with 0% controller output is applied (emergency stop).
3. Pressure Stand-by Active Limit
An active power limitation value. It limits power to the “known good steady state power” required \pm the Pressure Stand-by Active Limit value. This improves safety for a very sensitive reacting pressure processes by avoiding large deflections.

Using Automatic stand-by

The automatic stand-by function is activated by setting the Pressure Stand-by Threshold to a value other than OFF. The unfiltered controller input is monitored (*not the slower filtered display value*), and when it leaves the band above or below the setpoint set by the “Pressure Stand-by Threshold” parameter, the output is immediately set to the steady state value stored when the process was first stable^(referring to Finding the Steady State Power below).

If the input recovers within the “Pressure stand-by recovery time”, the controller waits for two and half time the integral value ($2.5 * T_i$) and then returns to normal “running” conditions.

If the process input does not recover, the output remains at the steady state value until the Pressure stand-by recovery time has elapsed, at which time the controller is switched to manual mode at 0% power.

Note:

If the Pressure stand-by recovery time is set to OFF, the controller enters manual mode at the stored steady state value, immediately the Pressure Stand-by Threshold is exceeded.

Changing the setpoint while the Automatic stand-by is active will cancel the stand-by sequence. It will not be able to activate until a new steady state value has been found.

**The old model ATC880 monitor the input and output the feature only began if the threshold was passed and the output was at saturation. ATC990 monitors the input level, but not output saturation because the process could see heavy disturbances before the output is saturated.

Automatic stand-by Example

For example, in a process with these conditions set: Setpoint=6000; Pressure Stand-by Threshold =200 Stand-by Recovery Time=30seconds; Stand-by Active Limit=20.0 and Integral Time(Ti)=10seconds

1. Stand-by begins immediately at SP+Threshold (6200) or SP-Threshold (5800).
2. If normal input returns (within band of 5801 to 6199) in less that the recovery time, normal power resumes after 2.5x the integral time (25s).
3. If normal input does not resume in in less that the recovery time, 0% manual mode power is applied. The user must return the controller to automatic mode and allow a new steady state power to be stored before the feature can become active again.
4. If the recovery time=OFF, manual mode is instantly applied, with power set to the steady state value.

Finding the Steady State Power .

For a stable (steady state) condition, the process value must be inside the requested band [Setpoint ±Pressure Stand-by Threshold] for more than one minute. The power level needed to achieve the stable condition is called the steady state value. See figure 1a below.

Once calculated the stored value remains unchanged until there is a change of the setpoint, or the controller is changed from automatic to manual mode. If this happens, a new steady state value must be found, and the automatic stand-by feature cannot function until it has been stored.

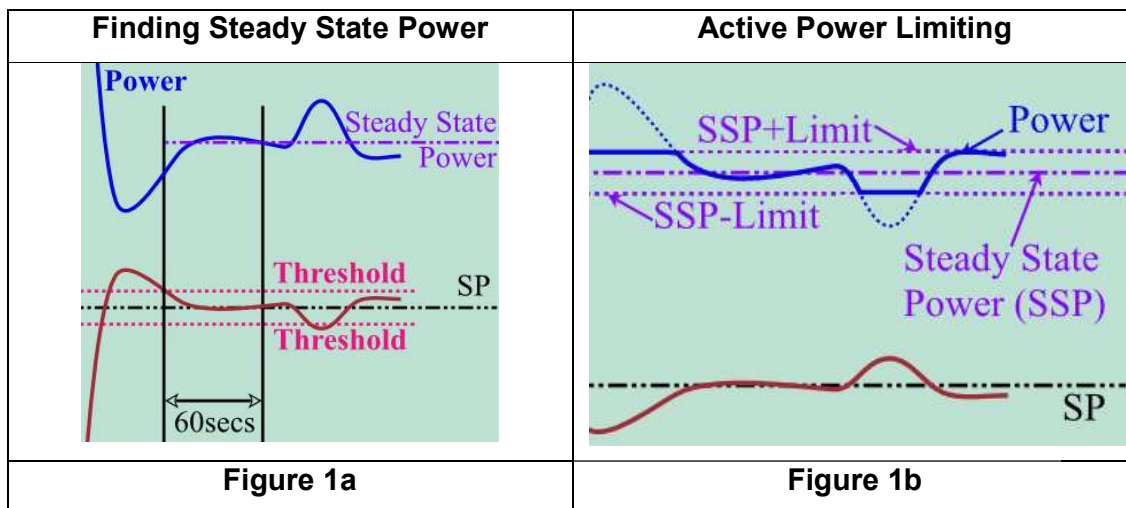

Using Stand-by Active Limit.

In addition to the automatic stand-by feature itself, further protection to the process is given by the Stand-by Active Limit. Its purpose is to limit the output swing possible in very sensitive reacting pressure process. This works by limiting the power applied to the process to not more/less than the stored steady state value \pm the Stand-by Active Limit set by the user. See *figure 1b above*.

If the stored steady state value=50% and stand-by active limit=20%, the overall limits would be 30% to 70%.

Setting a Stand-by Active Limit value of 100% would effectively disable this function.

Note:

If the Steady State Power level has not been found (or is reset because of a setpoint change or switch to manual mode) the power limits are 0% and 100% until the new value is stored.

14 Appendix 3 - PC SOFTWARE

The primary function of the software is to create, download and store instrument configurations and profiles. If the data recorder feature is fitted, its recordings can be downloaded and analysed via the software.

There are several extra features that are only possible via the software. Changes can be made to the operation of the instrument by adding extra screens into operation mode, enabling and configuring a “Supervisor Mode”, as well as changing the contact details, alarm status labels or the functions and labels of the front LED’s. You can download a new language file or customise the controller by changing the start-up “splash screen”.

An on-screen simulation of the instrument can be setup and tested on a configurable load simulation prior to downloading the settings to an instrument.

An additional software tool is available to set the IP address required for the Modbus TCP communications option - *refer to Network Configuration below.*

Using the PC Software

The menus and button bar are used to select the main parameter screens or one of the other modes or functions. Hover the mouse over the parameter description or value to view a fuller description. Consult the comprehensive help (available from the Help Menu) for information about the general software functions.

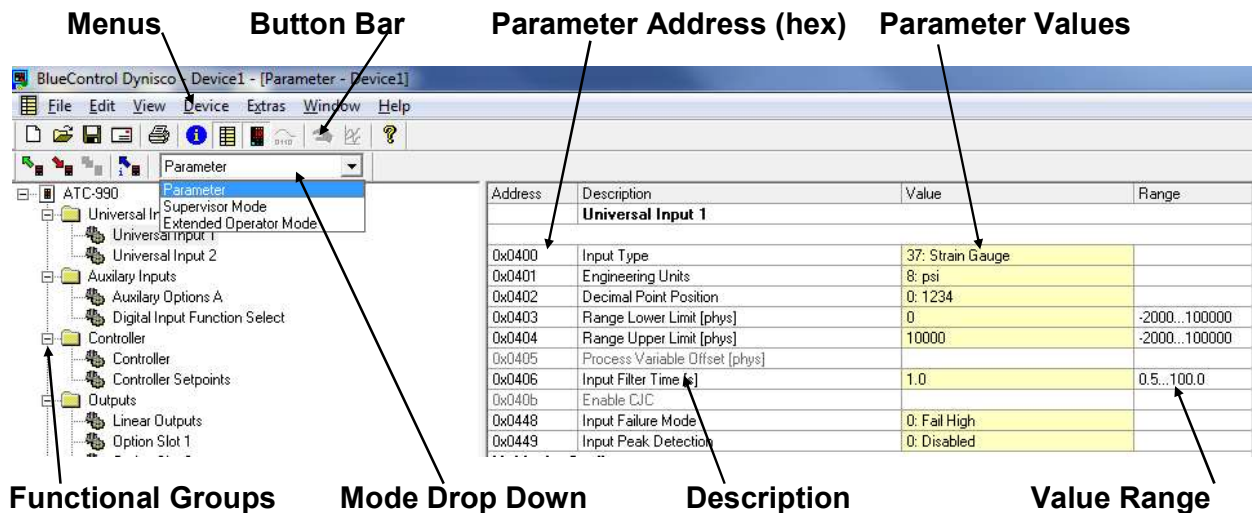

Figure 28. Main Parameter Screen

The main parameter screen is used to change the configuration and other instrument settings. This screen also allows access to the Supervisor and Enhanced Operation Mode configuration screens from the Mode drop-down list. *Refer to the relevant sections of this manual for full information on the various instrument modes and parameters.*

The Button bar, Device and View menus are used to access the other software functions.

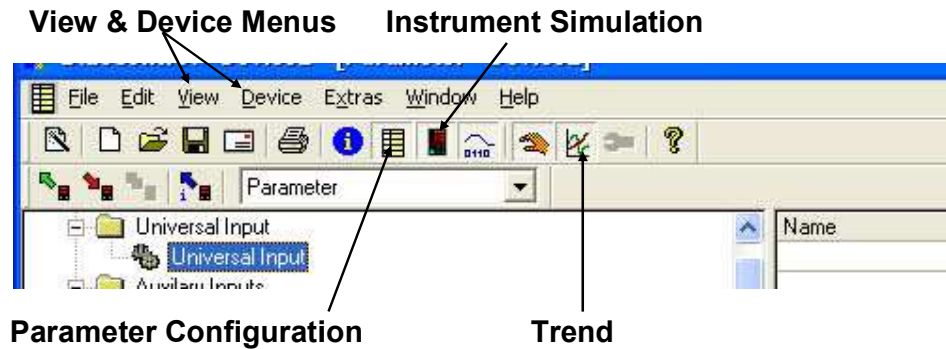

Figure 29. Button Bar & View Menu

Instrument Simulation

The software has a fully functional and interactive instrument simulation that includes a configurable simulated process, allowing the instrument settings to be tested before use.

Inputs are simulated in the top panel. A value (in display units) entered in INP1 & INP2 will override the values from the simulated processes or for a linear inputs, a mA or VDC value preceded by # (e.g. #12.0) can be used to verify the scaling. # does not work with Strain Gauge inputs. Enter F to simulate a sensor break. Tick boxes simulate the digital inputs

Active analogue and digital outputs are indicated in the lower panel.

The simulated instrument can also be accessed and configured by pressing its "buttons" with your mouse, or by using the 4 arrow keys on your keyboards.

Figure 30. Instrument Simulation

Configuring the Connection

The software communicates with the instrument using Modbus via the RJ11 configuration socket located on the underside of the case, or via the Ethernet or RS485 options if fitted. Refer to the wiring section for connection details.

The configuration socket is intended for initial configuration before installing the instrument in the application. An RS232 to TTL lead (available from your supplier) is required to connect this socket to your PC's RS232 serial port or USB to RS232 adaptor.

A front mounted USB port is available on some models; this can also be used to configure the instrument or transfer profile files, via a USB memory stick.



CAUTION: The configuration lead/socket is not isolated from the process input or SSR Driver outputs. It is not intended for use in live applications.

A communications settings screen is shown whenever the user attempts to connect to the instrument from the software. If the settings are not in-line with the information below, the software may not be able to communicate with the instrument.

Connection from PC to Bottom Configuration Socket

When using the built-in configuration socket, set the communications parameters as shown here and in the following table.

- **Device connector** = Configuration Socket
- **PC connector** = the PC Serial Com port number you are connected to
- **Start and Stop bits** = 1
- **Data bits** = 8.
- **Parity, Bit Rate & Address** = must match settings in the table below



Note: *When uploading or downloading via the bottom mounted configuration port, the required software communication settings depend on the module fitted in slot A. See the table below.*

Settings		<u>Slot A Module</u>	<u>Bit Rate</u>	<u>Parity</u>	<u>Address</u>
Device connector	Bus	Slot A Empty	19200	None	1
PC connector	COM1	Ethernet Comms	9600	None	1
Start bits	1	RS485 Comms	Must match the Communication Configuration menu settings.		
Data bits	8				
Stop bits	1				
Parity	none				
Bit rate	19200				
address	1				

Connection from PC to Rear RS485 Communications Option

When using the optional RS485 communications, set the parameters as shown here.

- **Device connector** = Bus
- **PC connector** = the PC Serial Com port number you are connected to
- **Start and Stop bits** = 1
- **Data bits** = 8
- **Parity, Bit Rate & Address** = must match the settings in the instruments own Communication Configuration menu.

Connection from PC/Network to Ethernet Port

When using the optional Ethernet communications, set the parameters as shown here.

- **Device connector** = Bus
- **PC connector** = Ethernet (bus coupler)
- **IP Address** = Instrument IP address*
- **Port Address** = 502.

Device connector	Bus
PC connector	Ethernet (bus coupler)
IP address	192.168.1.12
Port address	502

The supported data rates 10/100BASE-T (10 or 100 Mbps) are automatically detected.



Note: *An IP address must be set before connecting via Ethernet. Use the default address of 0.0.0.0 if your network uses DHCP, BootP or AutoIP or ask your network administrator for a valid address.

Most networks will assign the IP address automatically, but you can use the Lantronix XPort® DeviceInstaller™ tool if you need to assign or change the IP address manually. For the latest version, go to: www.lantronix.com/device-networking/utilities-tools/device-installer.html

Changing the IP Address

Connect the instrument to your network by plugging an Ethernet cable into the top mounted RJ45 socket. Run the DeviceInstaller™ tool from a PC on the same network. The tool should automatically find this and any other controllers on the network. If not use the search button.

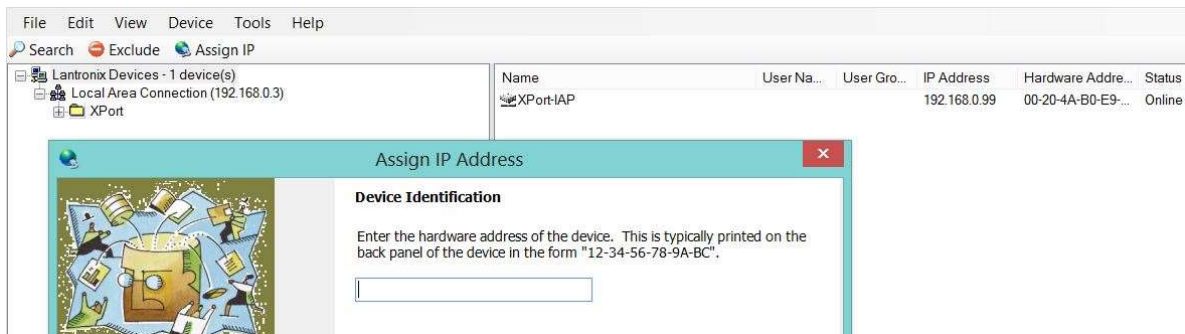

The existing IP and Hardware (MAC) addresses are shown for the instruments found.

Click the Assign IP button and enter the correct hardware address from the list (if necessary, confirm the number by comparing the hardware address with the number printed on Ethernet adaptor label).

At the next screen, choose whether to obtain the IP address automatically or to enter a specific address. For automatic addresses, select the protocols supported on your network (DHCP, BootP or AutoIP). For a specific address, enter the address, sub-net mask and default gateway information. Your network administrator will be able to provide this information. Press the assign button to confirm.

It is recommended to keep all other Ethernet device settings at the default values. If you do change the internal interface transfer speed or parity, matching settings must be made to the instruments Modbus data rate and parity settings in the communications configuration menu.



Note: You can enter any valid IP address, perhaps for use in another location, but if the number used does not match your existing network settings, further communication with the instrument will cease.

USB Memory Stick Folders & Files

If a USB flash drive is used to transfer files between instruments and/or the software, the files must be stored in specific **DEVICE**, and **CONFIG** folders. When saving files from the software to the USB stick, always ensure they are saved to the correct folder. Local file storage on your PC can be in any location. The USB option also limits the file name to 8 characters plus the 3 digit .bct or .pfl extension. Longer file names will be truncated.

The screenshot shows a Windows Explorer window for a removable disk (E:). A red circle highlights the root directory. Inside, there are folders: DEVICE, CONFIG, PROFILE, RECORDER, JUN-11-8, LOG23, and OVEN1. Arrows point from text descriptions to these folders.

- DEVICE** – This folder must be located in the Root of the USB memory stick
- CONFIG** – Configuration files (*.bct)
- RECORDER** – Recorder log folders/files. These can be created or saved from the PC software.



CAUTION: When saving a file, the data will be overwritten if the file name already exists.

Instrument Configuration

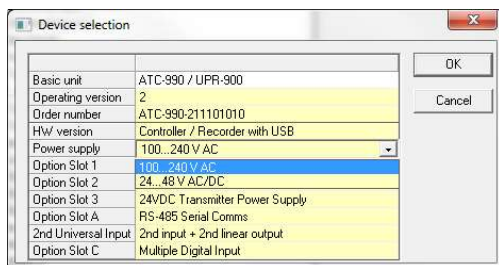

When creating a new configuration with the software, the basic instrument type and the options fitted to it must be defined in the Device Selection screen. You can select these from the drop down lists or by typing the full model number in the Order number field.



Note: Note: It is important that the options selected match those fitted to your unit.

Alternatively the complete instrument type and existing configuration can be uploaded to the PC from your instrument, via the configuration socket or serial communications. A previously saved configuration file can be opened from the file open menu or button.

Main Parameter Adjustment

The main parameter screen contains the configuration settings broken down into functional groups similar to the instruments' menus. The parameters can be changed in the yellow Value column. Type in new values or select from the list offered. Invalid values will be highlighted in red (possible values are shown to the left). Parameters are "greyed out" if they are inaccessible due to the hardware not being fitted or if they are disabled by other settings.

Once the required changes are made, the configuration can then be downloaded to the instrument, saved to hard disk or USB stick with a .bct file extension. The file contains the

device information and configuration parameter settings, including any supervisor and enhanced operation mode screens or changes to LED functions. Splash screens and data recordings are not saved in the .bct file. They are uploaded/saved separately.

Extending Functionality via Software

LED Functions & Labels

The allocated functions and descriptive labels for the 4 LED indicators can be changed with the PC software, replacing the default STBY; ALM1; ALM2; TUNE functions. These parameters can be found in the LED settings section of the software's Display Configuration functional group.



Configuring the Supervisor Mode

The purpose of the supervisor mode is to allow selected operators access to a “lock-code” protected sub-set of the configuration parameters, without giving them the higher level configuration menu unlock code. Up to 50 configuration parameters can be selected for inclusion in the supervisor mode screen sequence. If the parameter is normally displayed on screen with another parameter, both parameters will appear.

It is not possible to configure supervisor mode screens without using the software.

To define these screens, first select Supervisor Mode from the mode drop-down list, then select the functional group containing the parameter to be added. Highlight the parameter name and click the Add Entry button. The Move Entry Up and Down buttons are used to change the order which the parameters will appear in the instruments' Supervisor Mode. Unwanted entries can be highlighted and deleted with the Remove Entry button.

Configuring Custom Display Screens for the Extended Operator Mode

Users can access a sub-set of the configuration parameters at the end of the normal operation mode if this additional screen sequence is defined from the software. Up to 50 parameters from configuration menus can be selected for inclusion in the screen sequence. If the parameter is normally displayed on screen with another parameter, both parameters will appear.

It is not possible to configure custom display screens without using the software. To define these screens, first select Extended Operator Mode from the mode drop-down list, then select the functional group containing the parameter to be added.

Highlight the parameter name and click the Add Entry button. The Move Entry Up and Down buttons are used to change the order which the parameters will appear at the end of the normal operator screens.

Unwanted entries can be highlighted and deleted with the Remove Entry button.



Note: Any parameters copied into the custom display screens are not password protected. They can be freely viewed and adjusted by anyone with access to the instrument keypad.

Functional Groups Mode Drop Down Parameter List Selected Parameters

Add Entry Remove Entry Move Up Move Down

The screenshot shows the ATC-990 configuration software. On the left is a tree view of functional groups including Universal Inputs, Auxiliary Inputs, Controller, Outputs, Alarms, Data Recorder, and HMI. On the right is a parameter list for 'Universal Input 1' with columns for Address and Description. Below the list are icons for adding, removing, moving up, and moving down entries.

Figure 31. Supervisor/Enhanced Operation Mode Configuration

Changing the Start-up Splash Screen

The graphic shown during the instrument start-up sequence can be changed by selecting the Download Splash Screen option from the Device menu. Choose your new graphic file (most common graphic file types are supported).

The chosen image will be converted to monochrome and be rescaled to 160 pixels wide by 80 pixels high. For best results, the image should be simple and have an aspect ratio of 2:1. Complex graphics with multiple colours or greyscales will not reproduce well. A preview of the results is shown. Click the Download button to store it to the instrument.

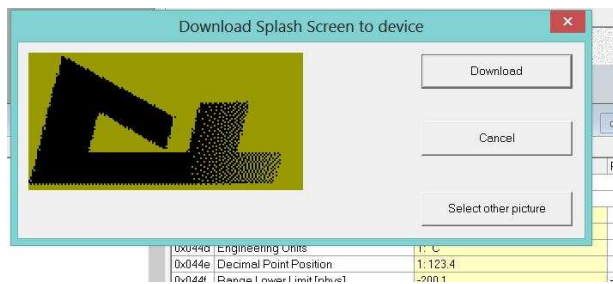

Data Recorder Trend Upload & Analysis

Uploading Data

Recordings can be transferred to a memory stick using the optional USB Port, or they can also be uploaded directly to your PC or network with the software, via the configuration port or RS485/Ethernet communications if fitted. To upload from a connected instrument, go to the Device | Upload recorder Data menu in the software. Select a folder location and enter a file name when prompted, then click Save. Enter the communications parameters for your connection, and click OK to save the data in Comma Separated (.csv) format.

Analysing Data

The data can be opened and analysed with the PC software, or with any spreadsheet. It can also be imported into other software that can interpret a .csv file.

To analyse a recording file in the PC software, go to the File | Open Trend menu. Locate and open the .csv file. The recording opens with the analogue traces (process, power or setpoint values) in the main window at the top, and digital traces (alarm or events statuses) below.

The settings button allows trend data channels to be made visible/invisible, or change their colour and scaling. Click & drag your mouse over an area of interest to zoom in (use the un-zoom button to cancel) or move the cursor line to that area to see the instantaneous analogue values and the alarm & event statuses.

Enable Cursor **Un-Zoom** **Settings** **Cursor Line** **Trend Settings**

Status/Value at Cursor **Analogue Traces** **Alarms/Events** **Visibility & Format**

Setting	Value
Cycle time	1550 ms (0 min)
At end of recording	Overwrite old data
Left scale	—
Right scale	PV 2
Time scale	absolute

Name	Visible	Title	Color	Min	Max
a1: PV	<input checked="" type="checkbox"/>	PV	Green	0.000	1000.0
a2: PV 2	<input checked="" type="checkbox"/>	PV 2	Red	0.000	1000.0
d1: Alarm 1 Status	<input checked="" type="checkbox"/>	Alarm 1 Status	Black		
d2: Alarm 2 Status	<input checked="" type="checkbox"/>	Alarm 2 Status	Black		
d3:	<input checked="" type="checkbox"/>		Black		

Project Documentation

The Project information (file name, instrument model code and version, modules / options fitted) and other user entered information such as the project name and version, operator details, creation and modification dates and a text description of the project can be entered into the file.

Projectinfo - Device1

Project name: New Product Treatment Test **Close**

Operator: John Smith - Project Leader **Help**

Version number: 3.0

Creation date: 6-AUG-2013 10:14:28

Change date: 6-AUG-2013 13:32:40

Description: Instrument configuration for test of new product following hardware re-design - refer to EICN005695

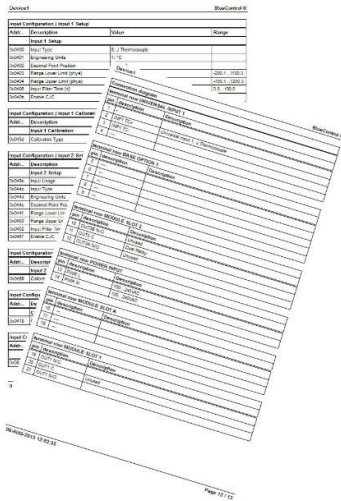

A hard copy of the instrument configuration can be printed from the File | Print menu.

This includes the project information, configuration parameters and their values, the Modbus parameter addresses, supervisor mode screens and the terminal wiring for your hardware and configuration.